



US00D626928S

(12) **United States Design Patent**
Bernstein et al.

(10) **Patent No.:** **US D626,928 S**

(45) **Date of Patent:** **** *Nov. 9, 2010**

(54) **CELL PHONE**

(75) Inventors: **Noam Bernstein**, Tel Aviv (IL); **Matthias Hamann**, Munich (DE); **Daniel von Waldthausen**, Munich (DE)

(73) Assignee: **Modu Ltd.**, Kfar Saba (IL)

(*) Notice: This patent is subject to a terminal disclaimer.

(**) Term: **14 Years**

(21) Appl. No.: **29/340,449**

(22) Filed: **Jul. 19, 2009**

(51) **LOC (9) Cl.** **14-03**

(52) **U.S. Cl.** **D14/138 AA**

(58) **Field of Classification Search** D14/341-347,
D14/147, 496, 203.3, 203.4, 203.7, 138 AA,
D14/138 R, 138 AD; 455/575.1, 575.4, 556.2;
379/433.01, 433.04

See application file for complete search history.

(56) **References Cited**

U.S. PATENT DOCUMENTS

- D265,735 S * 8/1982 Fukushima et al. D14/247
- D487,440 S * 3/2004 Langford D14/138 AA
- D488,483 S * 4/2004 Hu D14/496
- 6,920,344 B2 * 7/2005 Jang 455/575.5
- D511,347 S * 11/2005 Naruki D14/203.7
- D539,258 S * 3/2007 Wang et al. D14/138 AA
- D543,554 S * 5/2007 Dai D14/496
- D545,804 S * 7/2007 Lee D14/138 AA
- D546,346 S * 7/2007 Miyamori et al. D14/496
- D546,804 S * 7/2007 Lee et al. D14/138 AA
- D546,810 S * 7/2007 Kwak D14/138 AA
- D549,238 S * 8/2007 Chikuma D14/496
- D553,129 S * 10/2007 Andre et al. D14/341
- D553,604 S * 10/2007 Choi et al. D14/138 AA
- D555,126 S * 11/2007 Park et al. D14/138 AA
- D556,175 S * 11/2007 Hong et al. D14/138 AA
- D560,641 S * 1/2008 Jung et al. D14/138 AA
- D572,697 S * 7/2008 Lee et al. D14/138 AA

- D580,399 S * 11/2008 Kim et al. D14/138 AD
- D582,880 S * 12/2008 Kim et al. D14/138 AA
- 7,529,520 B2 * 5/2009 Edgren 455/90.3
- D594,031 S * 6/2009 Rayn D14/496
- D597,983 S * 8/2009 Bernstein et al. D14/138 AA
- D601,528 S * 10/2009 Lim et al. D14/138 AA
- D613,760 S * 4/2010 Pail D14/496
- 2009/0305755 A1 * 12/2009 Lee et al. 455/575.4

OTHER PUBLICATIONS

BenQ-Siemens EF51 telephone, announced Feb. 2006, [online], [site visited Mar. 26, 2010]. Available from Internet ,<URL: <http://www.gsmarena.com>>.*

Samsung P300 telephone, announced 4th quarter 2005, [online], [site visited Mar. 26, 2010]. Available from Internet ,<URL: <http://www.gsmarena.com>>.*

LG KE820 telephone, announced Oct. 2006, [online], [site visited Mar. 26, 2010]. Available from Internet ,<URL: <http://www.gsmarena.com>>.*

* cited by examiner

Primary Examiner—Jeffrey D Asch

(74) *Attorney, Agent, or Firm*—Soquel Group LLC

(57) **CLAIM**

The ornamental design for a cell phone, substantially as shown and described.

DESCRIPTION

FIG. 1 is an isometric view of a cell phone showing our new design;

FIG. 2 is a front elevational view thereof;

FIG. 3 is a back elevational view thereof;

FIG. 4 is a top plan view thereof;

FIG. 5 is a bottom plan view thereof;

FIG. 6 is a left elevational view thereof; and,

FIG. 7 is a right elevational view thereof.

The broken lines shown at the bottom in FIG. 5 represent the bounds of the claimed design; the broken lines form no part of the claimed design.

1 Claim, 7 Drawing Sheets

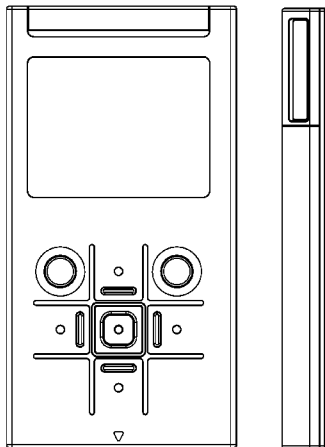

FIG. 1

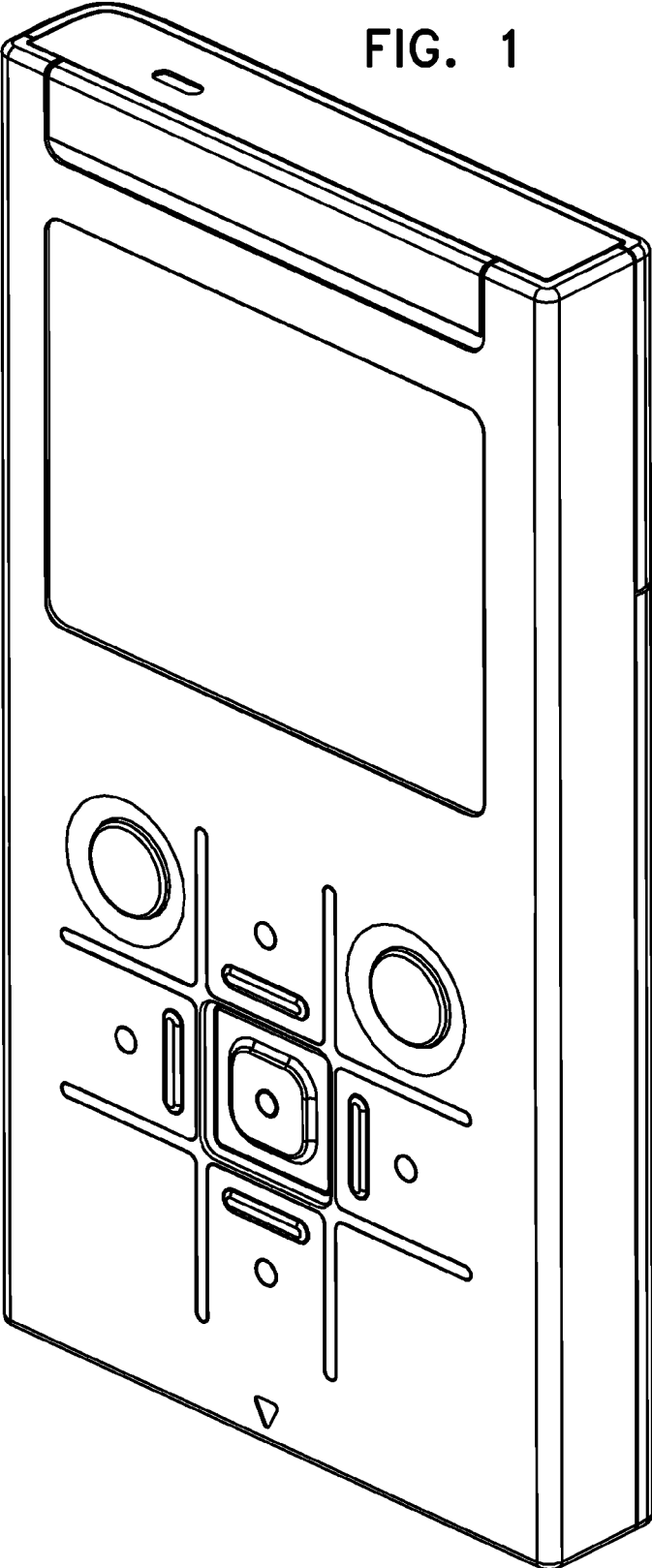

FIG. 2

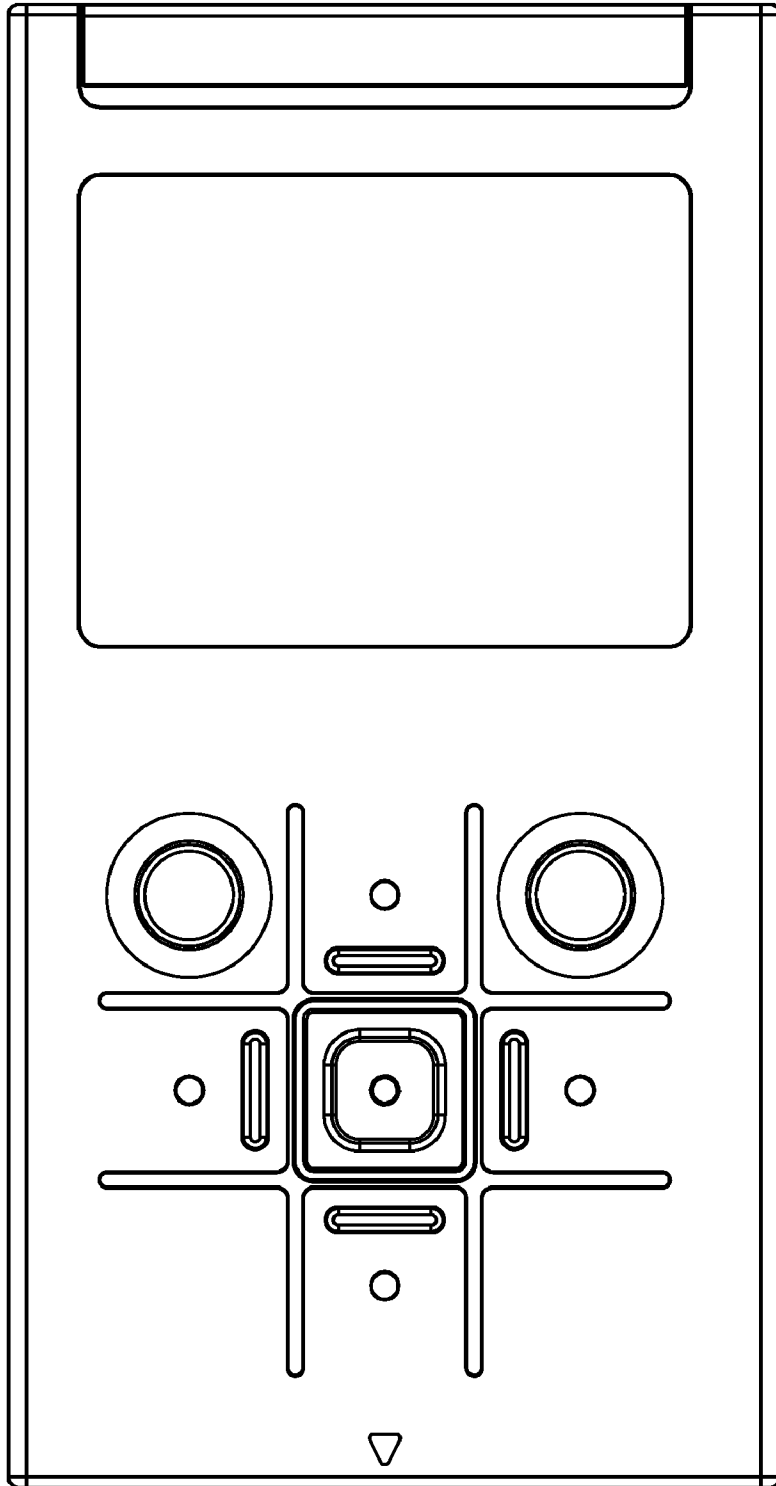

FIG. 3

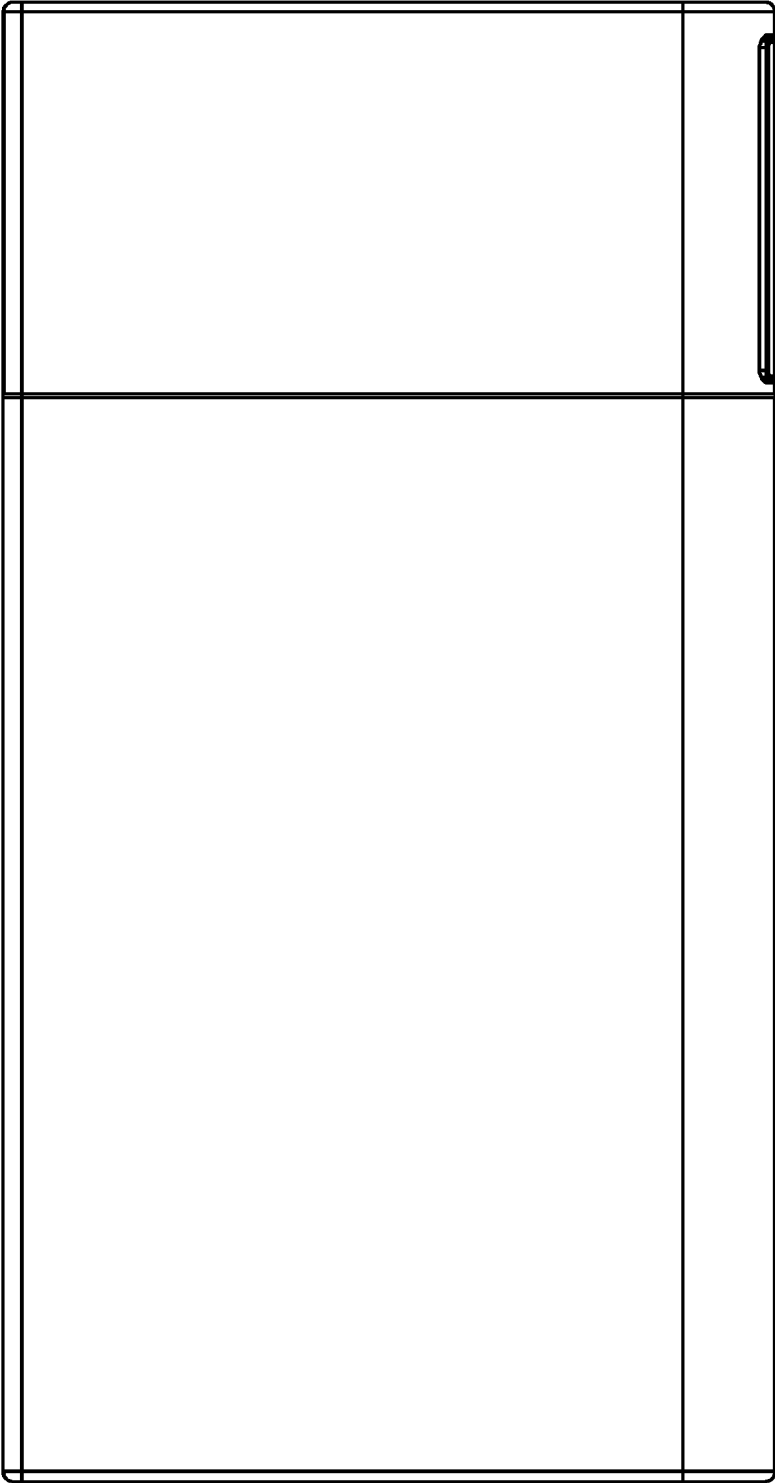

FIG. 4

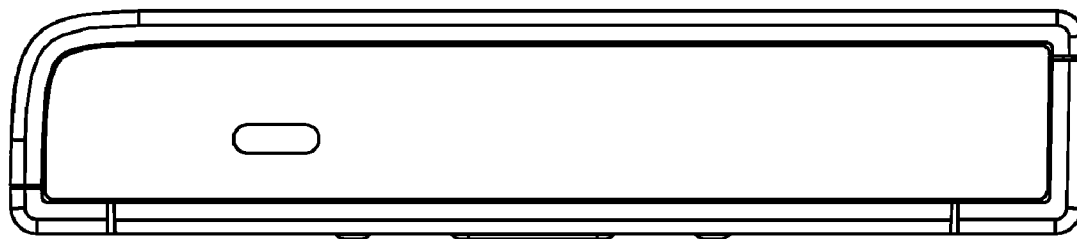

FIG. 5

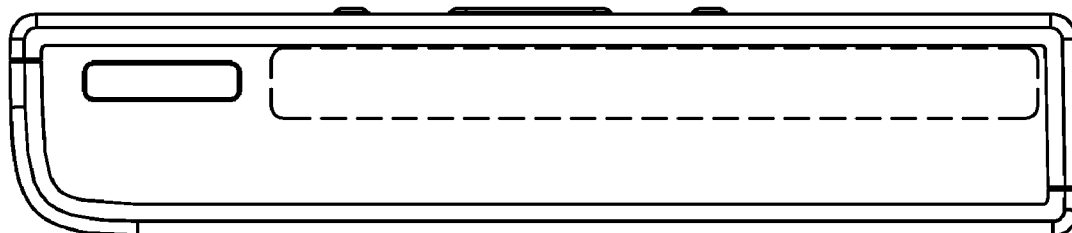

FIG. 6

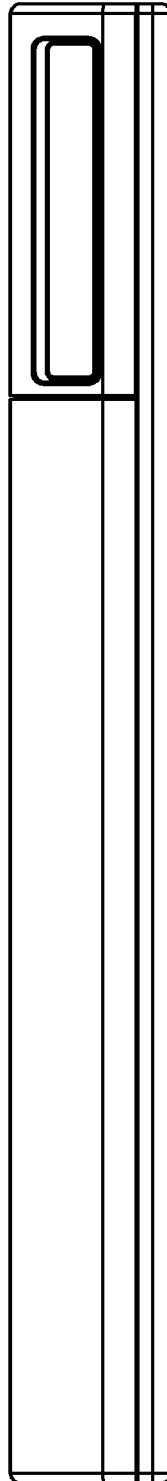

FIG. 7

