



US007627612B2

(12) **United States Patent**
Ahal et al.

(10) **Patent No.:** **US 7,627,612 B2**
(45) **Date of Patent:** **Dec. 1, 2009**

(54) **METHODS AND APPARATUS FOR OPTIMAL JOURNALING FOR CONTINUOUS DATA REPLICATION**

(75) Inventors: **Shlomo Ahal**, Tel-Aviv (IL); **Assaf Natanzon**, Ramat-Gan (IL); **Tzach Sechner**, Tel-Aviv (IL); **Oded Kedem**, Tel-Aviv (IL); **Evgeny Drukh**, Rehovot (IL)

(73) Assignee: **EMC Israel Development Center, Ltd.**, Netanya (IL)

(*) Notice: Subject to any disclaimer, the term of this patent is extended or adjusted under 35 U.S.C. 154(b) by 265 days.

(21) Appl. No.: **11/536,233**

(22) Filed: **Sep. 28, 2006**

(65) **Prior Publication Data**

US 2008/0082592 A1 Apr. 3, 2008

(51) **Int. Cl.**
G06F 12/00 (2006.01)
G06F 17/30 (2006.01)

(52) **U.S. Cl.** **707/202; 707/204**

(58) **Field of Classification Search** **707/202, 707/204**

See application file for complete search history.

(56) **References Cited**

U.S. PATENT DOCUMENTS

5,170,480	A *	12/1992	Mohan et al.	707/201
5,499,367	A *	3/1996	Bamford et al.	707/8
5,864,837	A	1/1999	Maimone	
6,065,018	A *	5/2000	Beier et al.	707/202
6,148,340	A	11/2000	Bittinger et al.	
6,260,125	B1 *	7/2001	McDowell	711/162
6,272,534	B1	8/2001	Guha	
6,574,657	B1	6/2003	Dickinson	
6,947,981	B2	9/2005	Lubbers et al.	
7,111,197	B2	9/2006	Kingsbury et al.	

7,139,927	B2	11/2006	Park et al.	
7,222,136	B1 *	5/2007	Brown et al.	707/202
7,296,008	B2	11/2007	Passerini et al.	
7,328,373	B2	2/2008	Kawamura et al.	
2002/0129168	A1	9/2002	Kanai et al.	
2003/0110278	A1	6/2003	Anderson	
2004/0250032	A1 *	12/2004	Ji et al.	711/162
2005/0015663	A1	1/2005	Armangau et al.	
2005/0172092	A1	8/2005	Lam et al.	
2005/0273655	A1 *	12/2005	Chow et al.	714/16
2006/0031647	A1	2/2006	Hirakawa et al.	
2006/0117211	A1	6/2006	Matsunami et al.	
2006/0212462	A1	9/2006	Heller et al.	
2007/0198602	A1	8/2007	Ngo et al.	
2007/0220311	A1	9/2007	Lewin et al.	
2007/0266053	A1	11/2007	Ahal et al.	
2008/0082591	A1	4/2008	Ahal et al.	

OTHER PUBLICATIONS

Michael Lewin; "Any Point In Time Data Access and Recovery;" U.S. Appl. No. 60/752,665, filed Dec. 21, 2005.

(Continued)

Primary Examiner—John R. Cottingham
Assistant Examiner—James E. Richardson
(74) *Attorney, Agent, or Firm*—Daly, Crowley, Mofford & Durkee, LLP

(57) **ABSTRACT**

Methods and systems for continuous data replication, including receiving a write transaction from a production site, the write transaction including raw data (RWNEW), a size indicator (SZ1) for the size of the raw data, and a start address (ADD1) for writing the raw data, copying the raw data (RWNEW) into a first journal data stream at a current journal address (JADD1), and copying the size indicator (SZ1), the start address (ADD1) and the journal address (JADD1) into a first journal meta-data stream.

16 Claims, 15 Drawing Sheets

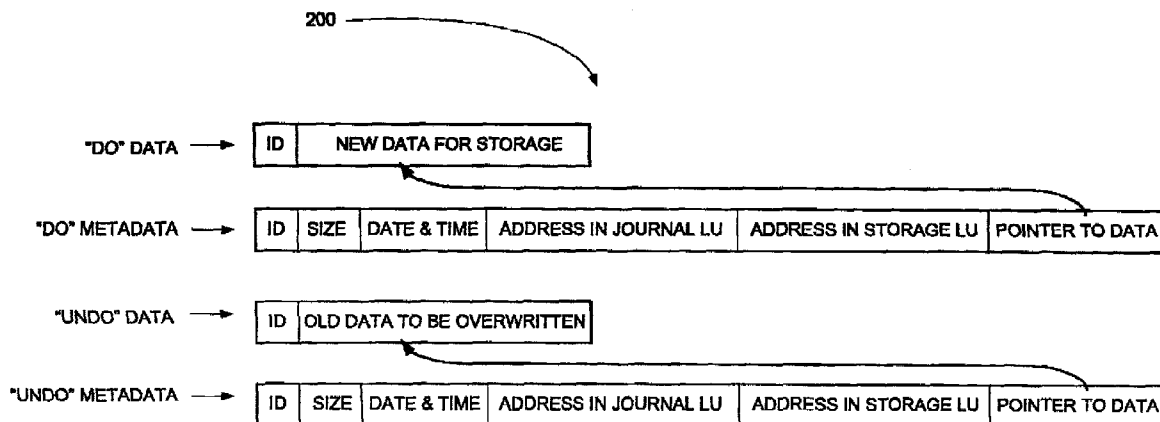

OTHER PUBLICATIONS

Shlomo Ahal; "Multiple Points In Time Data Access;" U.S. Appl. No. 60/753,263, filed Dec. 22, 2005.

Michael Lewin; "Methods and Apparatus for Point in Time Data Access and Recovery;" U.S. Appl. No. 11/609,580, filed Dec. 12, 2006.

Shlomo Ahal; "Methods and Apparatus for Multiple Point in Time Data Access;" U.S. Appl. No. 11/609,561, filed Dec. 12, 2006.

Michael Lewin; "Cross Tagging Of Data For Consistent Recovery;" U.S. Appl. No. 11/356,920, filed Feb. 17, 2006.

Yair Heller, "Apparatus For Continuous Compression Of Large Volumes Of Data;" U.S. Appl. No. 60/375,007, filed Apr. 25, 2002.

Yair Heller "An Apparatus For Continuous Compression of Large Volumes of Data;" PCT Application No. WO 03/092166 A1; filed on Apr. 1, 2003.

Shlomo Ahal, "Methods And Apparatus For Optimal Journaling For Continuous Data Replication;" U.S. Appl. No. 11/536,215, filed Sep. 28, 2006.

Shlomo Ahal, "Methods And Apparatus For Managing Data Flow In A Continuous Data Replication System Having Journaling;" U.S. Appl. No. 11/536,160, filed Sep. 28, 2006.

File downloaded from PAIR for U.S. Appl. No. 11/609,560, filed Dec. 12, 2006, file through Jun. 3, 2009, 466 pages.

File downloaded from PAIR for U.S. Appl. No. 10/512,687, filed Aug. 24, 2005, file through Jun. 3, 2009, 348 pages.

File downloaded from PAIR for U.S. Appl. No. 11/536,160, filed Sep. 28, 2006, file through Jun. 3, 2009, 155 pages.

File downloaded from PAIR for U.S. Appl. No. 11/609,561, filed Dec. 12, 2006, file through Jun. 3, 2009, 435 pages.

File downloaded from PAIR for U.S. Appl. No. 11/356,920, filed Feb. 17, 2006, file through Jun. 3, 2009, 552 pages.

* cited by examiner

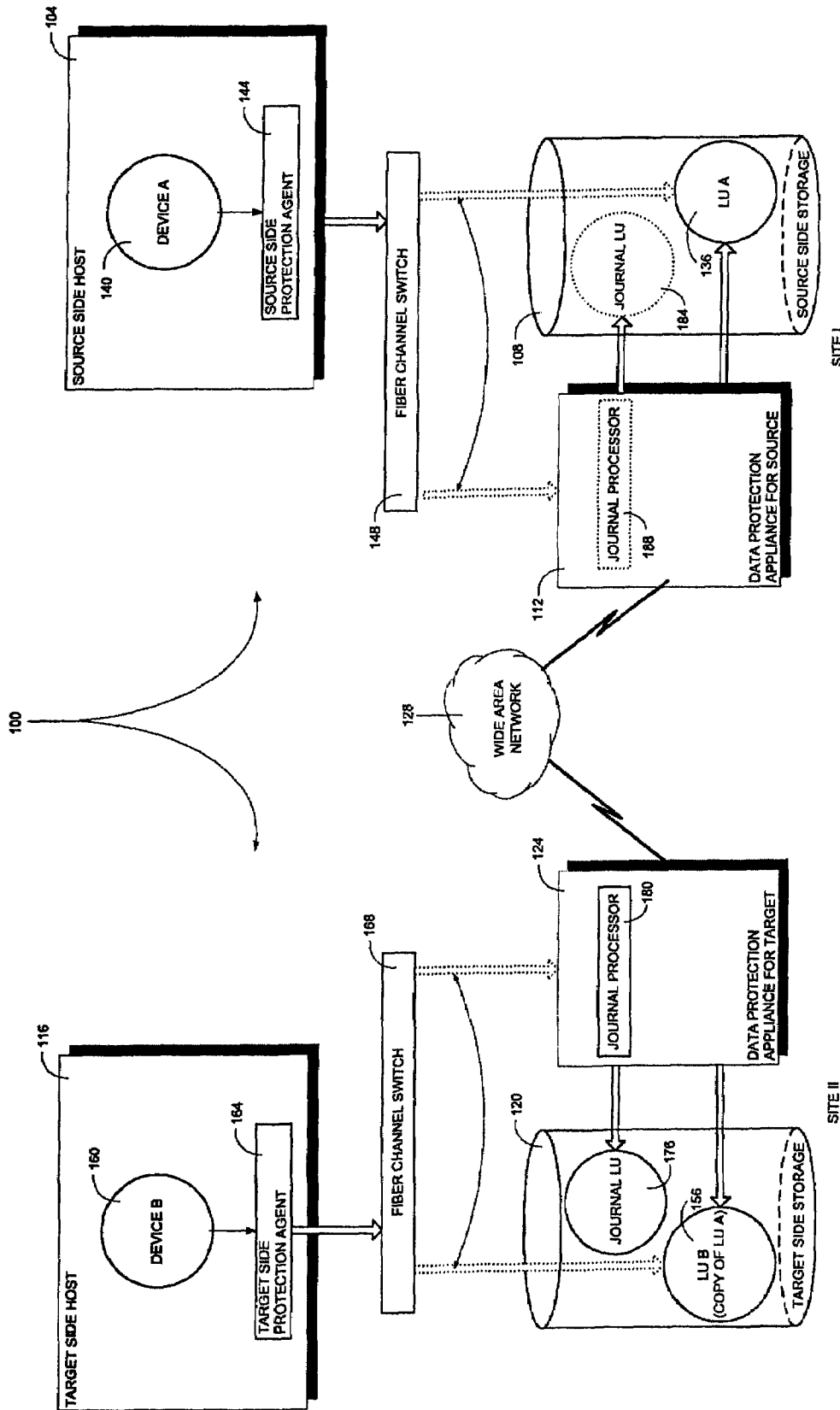

FIG. 1

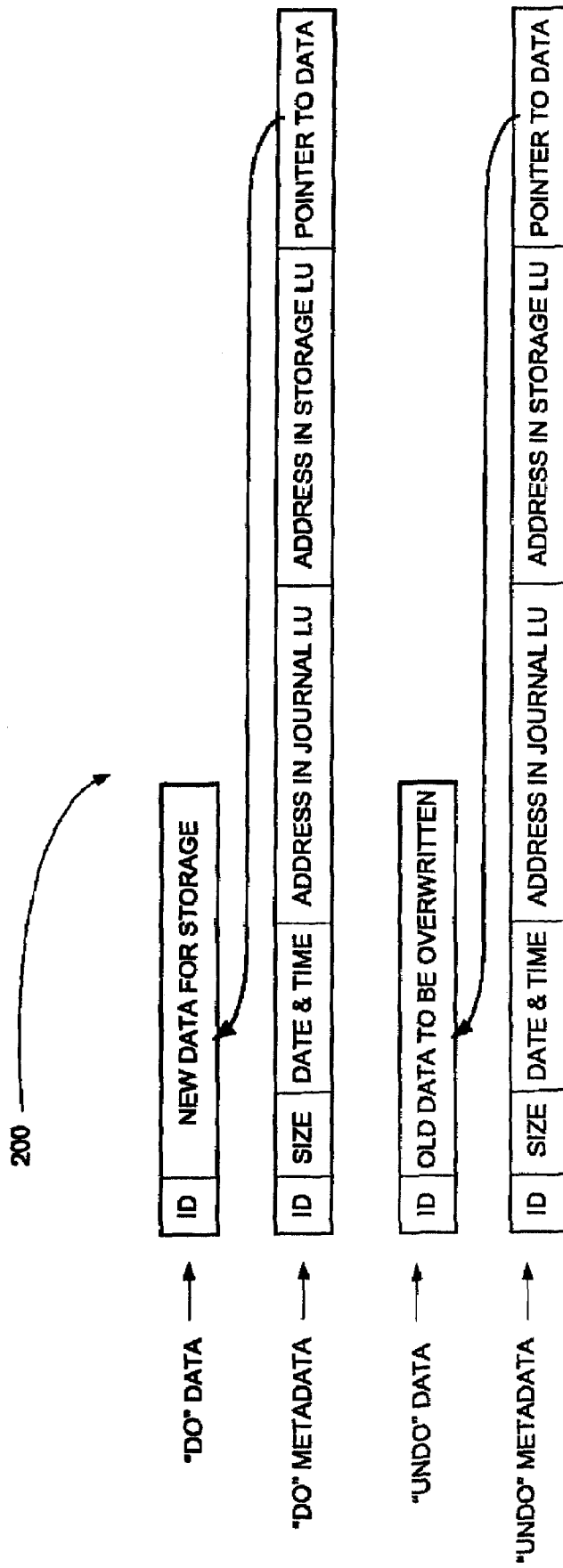

FIG. 2

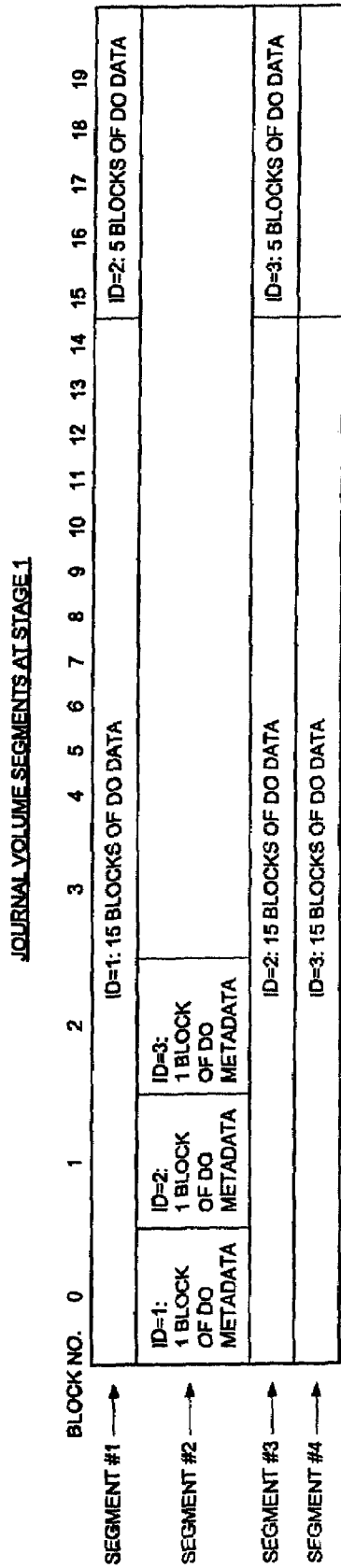

FIG. 3A

JOURNAL VOLUME SEGMENTS AT STAGE 2

BLOCK NO. 0	1	2	3	4	5	6	7	8	9	10	11	12	13	14	15	16	17	18	19
SEGMENT #1	ID=2: 1 BLOCK OF DO METADATA																		
SEGMENT #2	ID=3: 1 BLOCK OF DO METADATA																		
SEGMENT #3	ID=2: 15 BLOCKS OF DO DATA																		
SEGMENT #4	ID=3: 15 BLOCKS OF DO DATA																		
SEGMENT #5	ID=1: 15 BLOCKS OF UNDO DATA																		
SEGMENT #6	ID=1: 1 BLOCK OF UNDO METADATA																		

THE FOUR STREAMS

- DO STREAM INCLUDES SEGMENTS #1, #3 AND #4, BEGINS AT SEGMENT #1, BLOCK #15 AND ENDS AT SEGMENT #3, BLOCK #15
- DO METADATA STREAM INCLUDES SEGMENT #2, BEGINS AT SEGMENT #2, BLOCK #1 AND ENDS AT SEGMENT #2, BLOCK #3
- UNDO STREAM INCLUDES SEGMENT #5, BEGINS AT SEGMENT #5, BLOCK #0 AND ENDS AT SEGMENT #5, BLOCK #15
- UNDO METADATA STREAM INCLUDES SEGMENT #6, BEGINS AT SEGMENT #6, BLOCK #0 AND ENDS AT SEGMENT #6, BLOCK #1

FIG. 3B

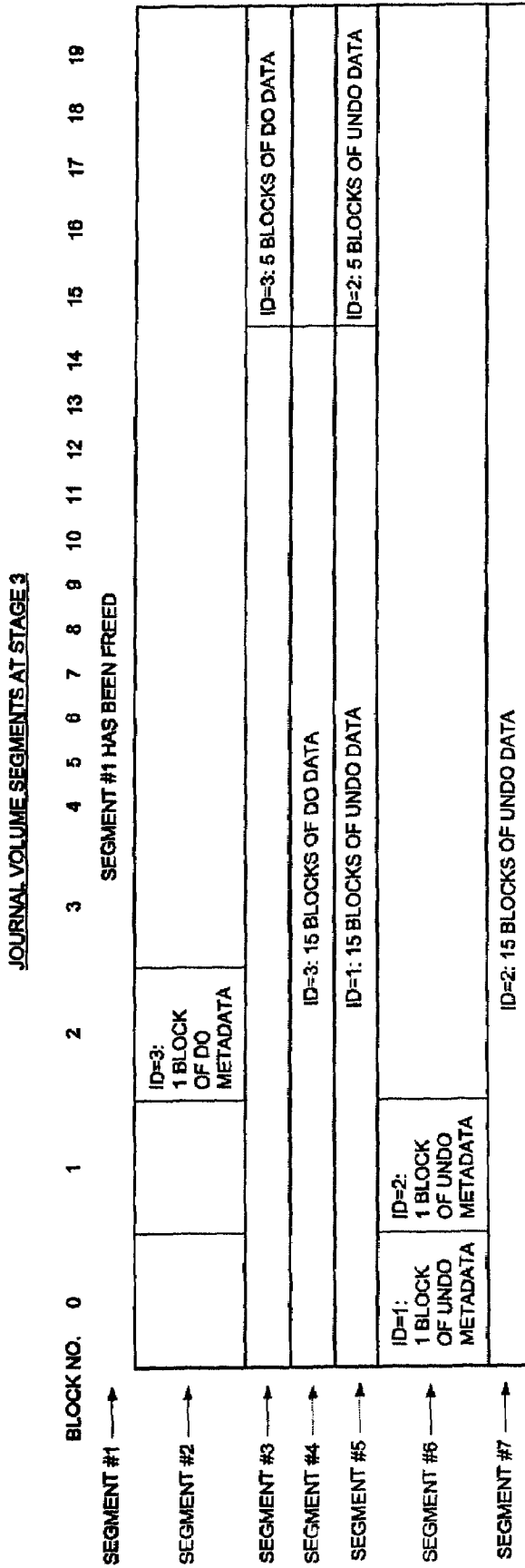

THE FOUR STREAMS

DO STREAM INCLUDES SEGMENTS #3 AND #4, BEGINS AT SEGMENT #3, BLOCK #15 AND ENDS AT SEGMENT #3, BLOCK #5
 DO METADATA STREAM INCLUDES SEGMENT #2, BEGINS AT SEGMENT #2, BLOCK #2 AND ENDS AT SEGMENT #2, BLOCK #3
 UNDO STREAM INCLUDES SEGMENT #5 AND #7, BEGINS AT SEGMENTS #5, BLOCK #0 AND ENDS AT SEGMENT #7, BLOCK #15
 UNDO METADATA STREAM INCLUDES SEGMENT #6, BEGINS AT SEGMENT #6, BLOCK #0 AND ENDS AT SEGMENT #6, BLOCK #2

FIG. 3C

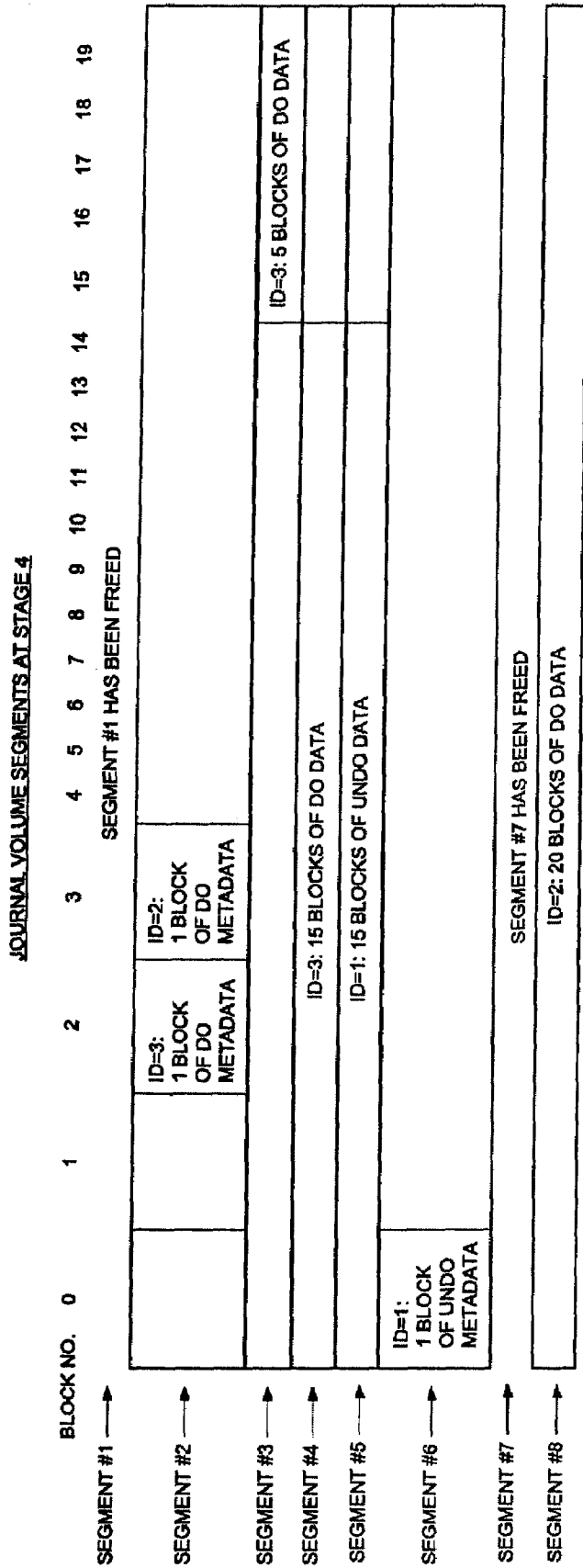

THE FOUR STREAMS

DO STREAM INCLUDES SEGMENT #3, #4 AND #8, BEGINS AT SEGMENT #3, BLOCK #15 AND ENDS AT SEGMENT #8, BLOCK #20
 DO METADATA STREAM INCLUDES SEGMENT #2, BEGINS AT SEGMENT #2, BLOCK #2 AND ENDS AT SEGMENT #2, BLOCK #4
 UNDO STREAM INCLUDES SEGMENT #5, BEGINS AT SEGMENT #5, BLOCK #0 AND ENDS AT SEGMENT #5, BLOCK #15
 UNDO METADATA STREAM INCLUDES SEGMENT #6, BEGINS AT SEGMENT #6, BLOCK #0 AND ENDS AT SEGMENT #6, BLOCK #1

FIG. 3D

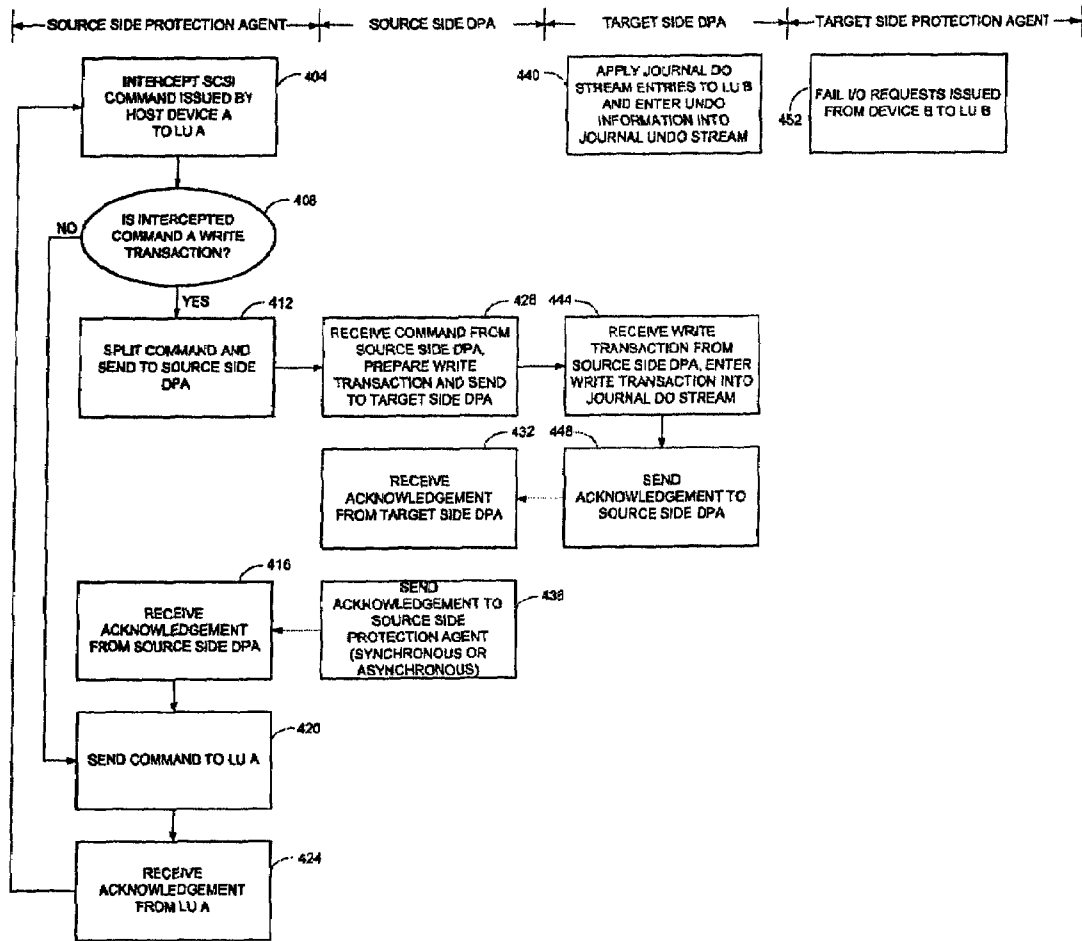

FIG. 4

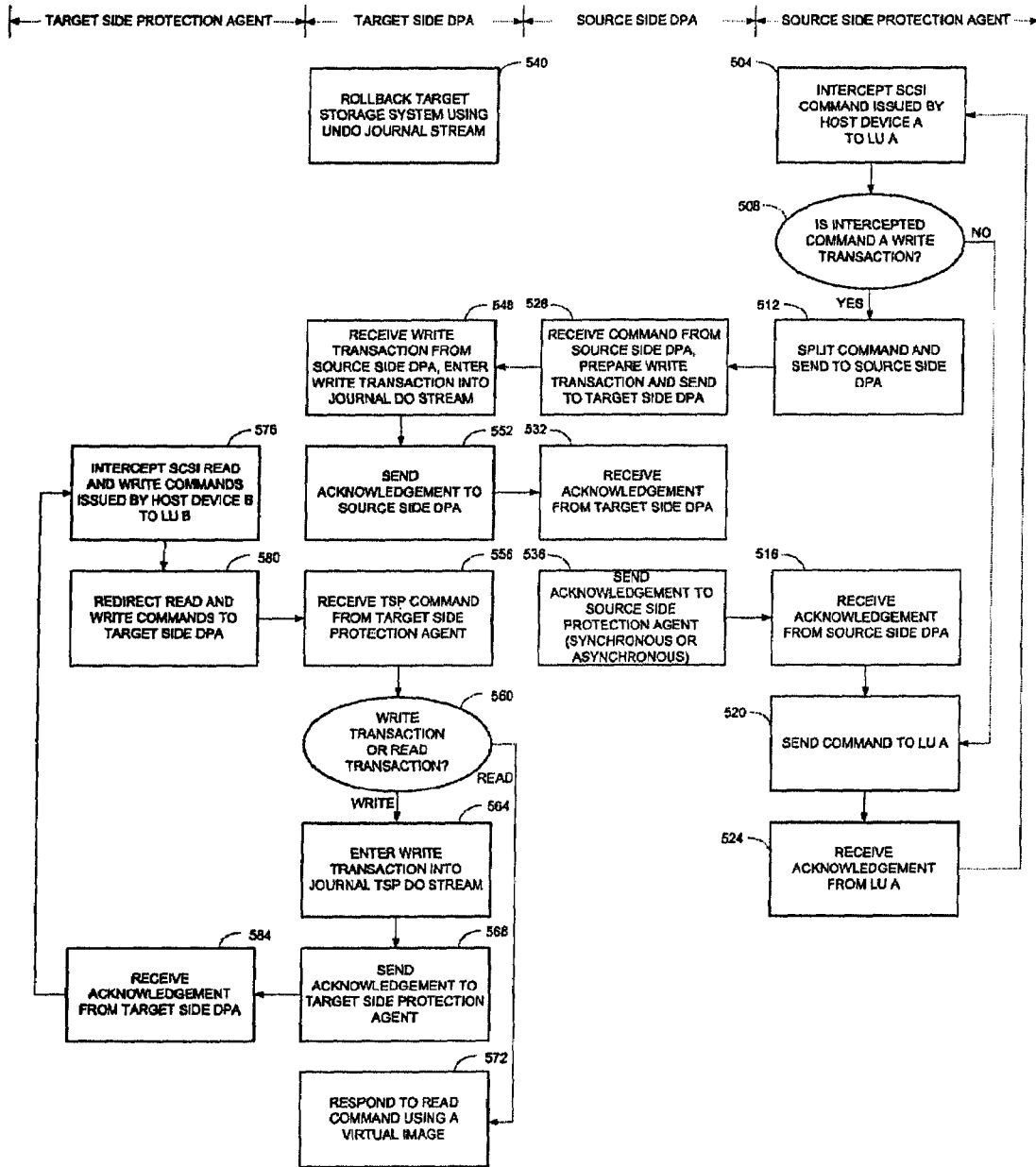

FIG. 5

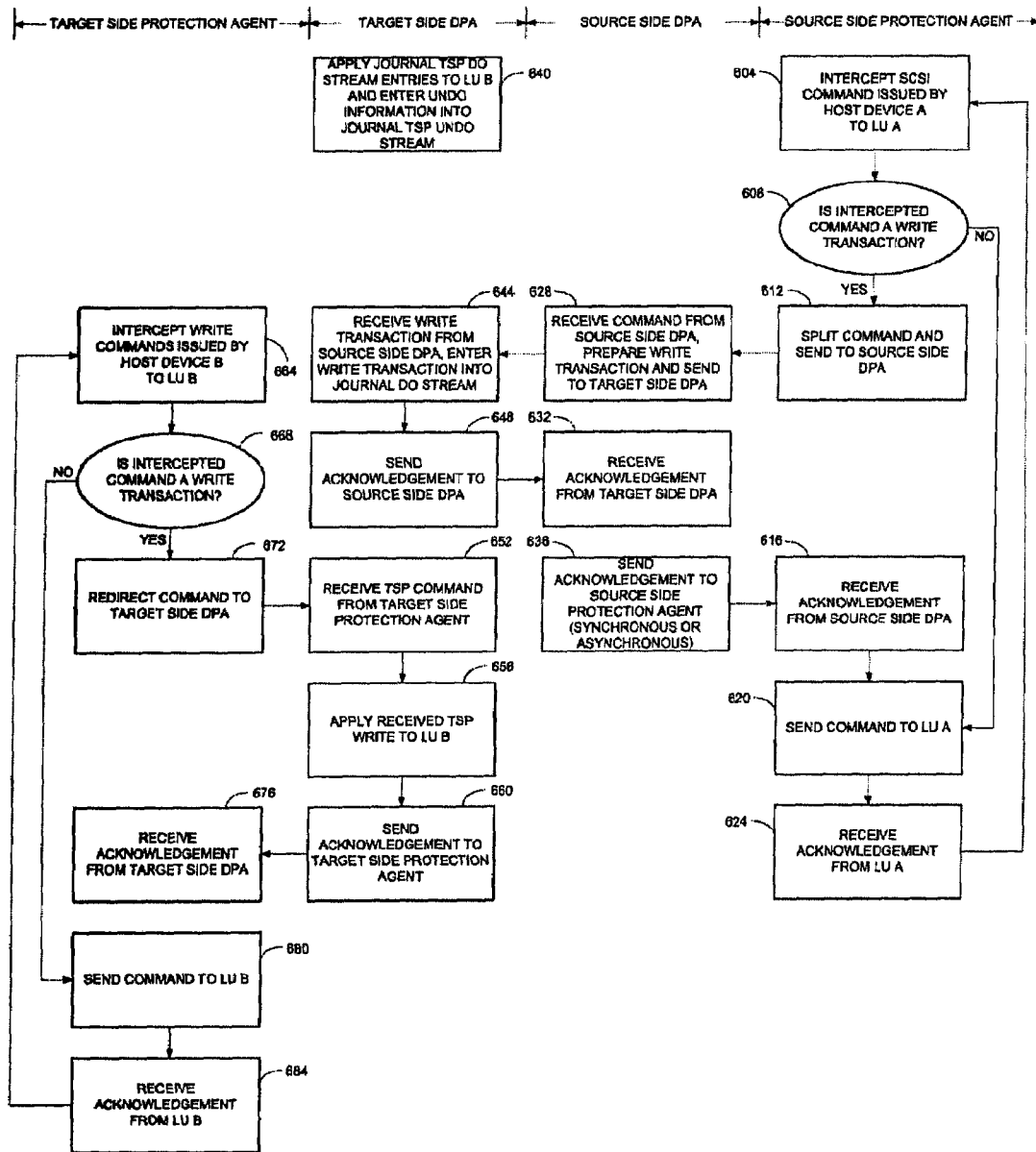

FIG. 6

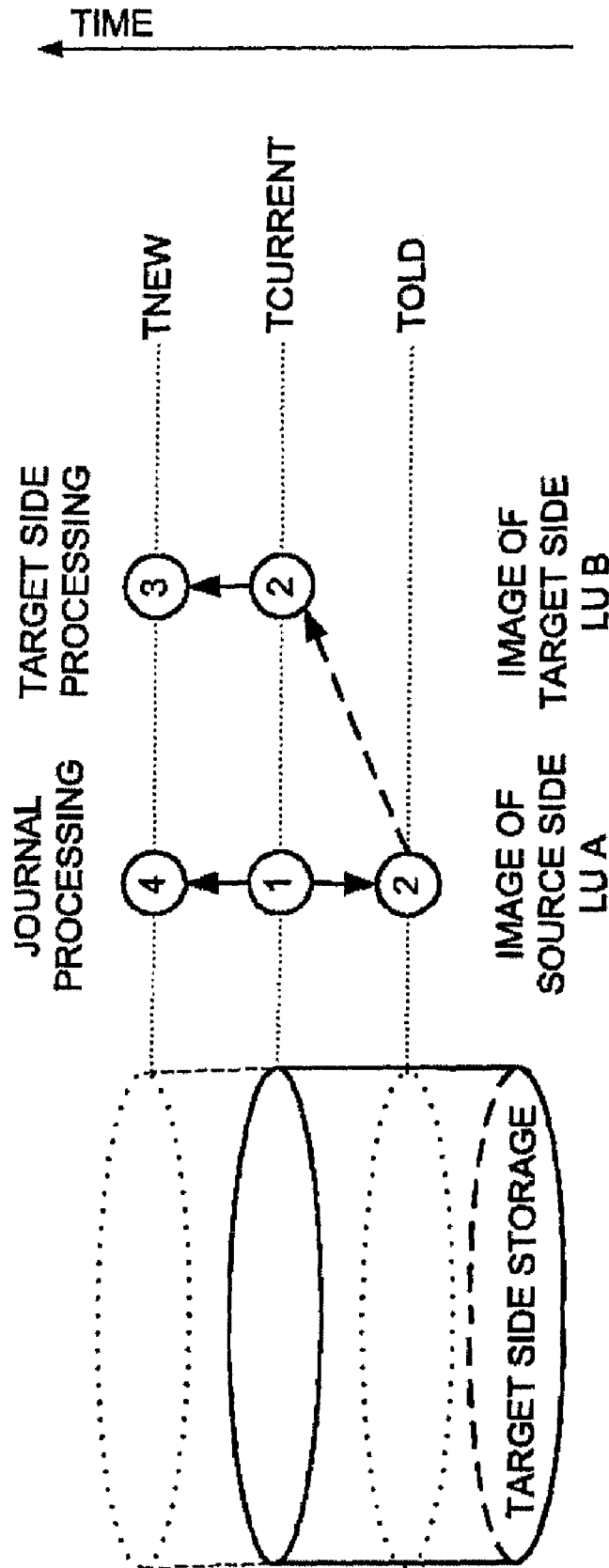

FIG. 7

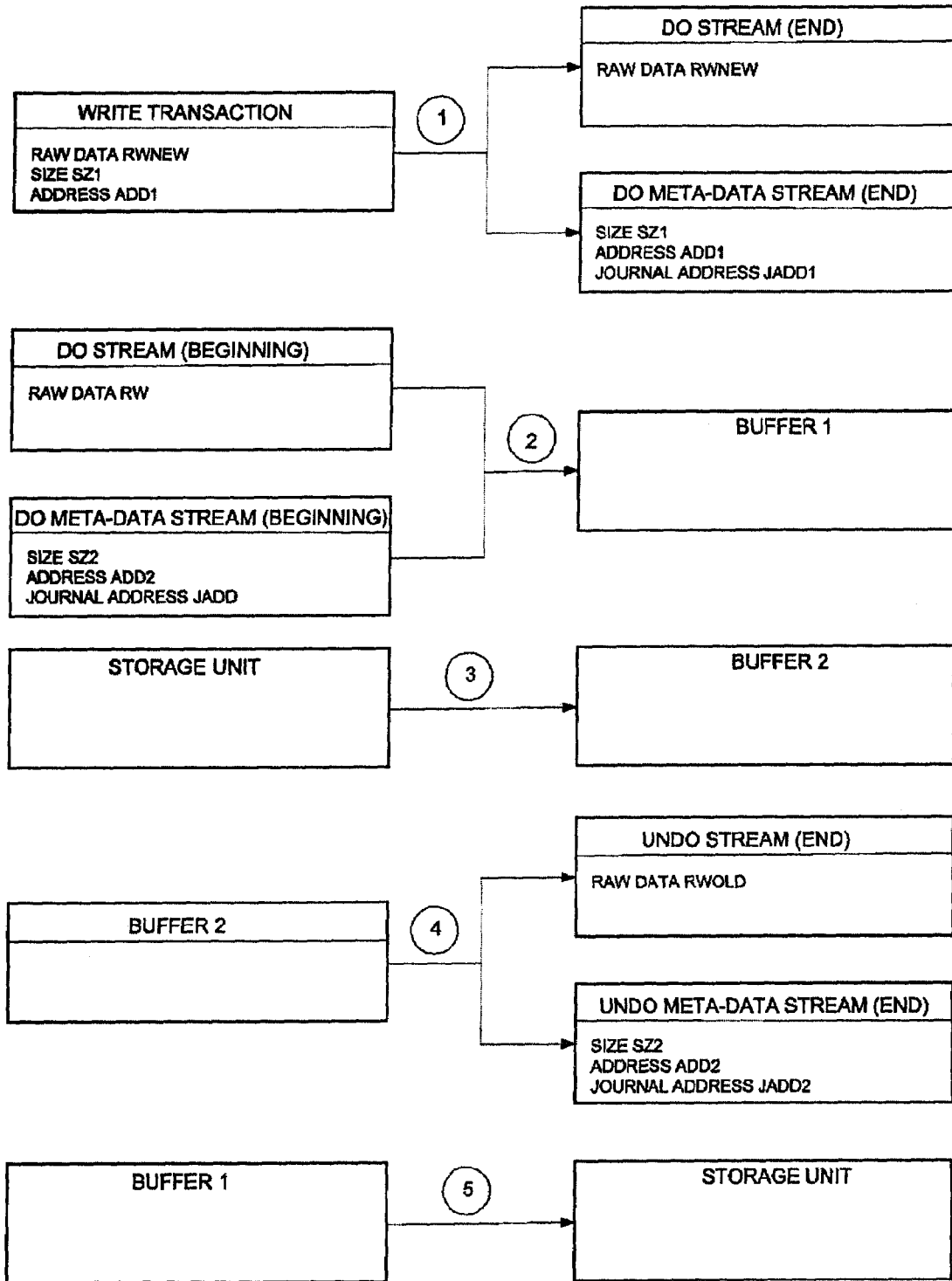

FIG. 8

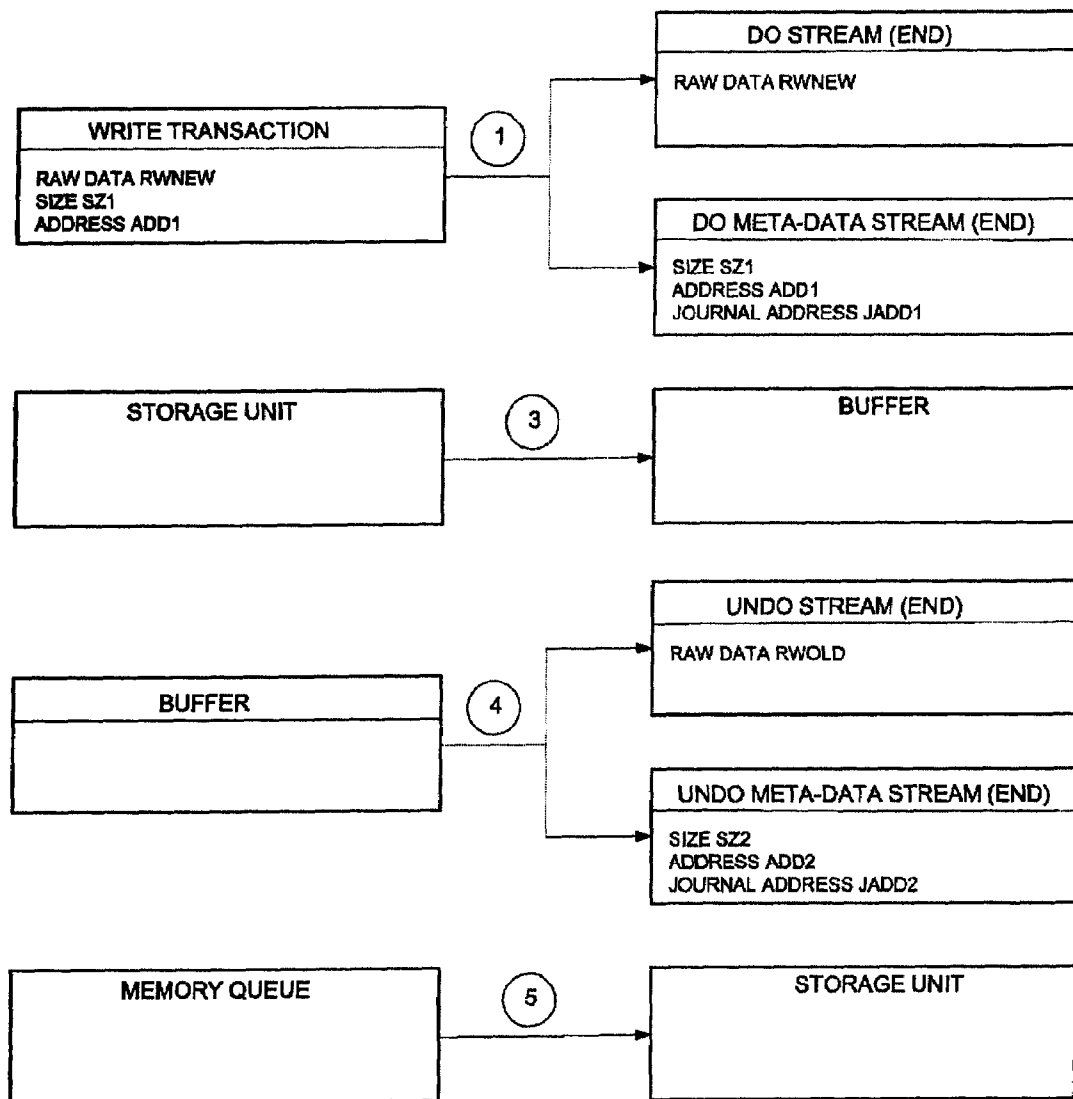

FIG. 9

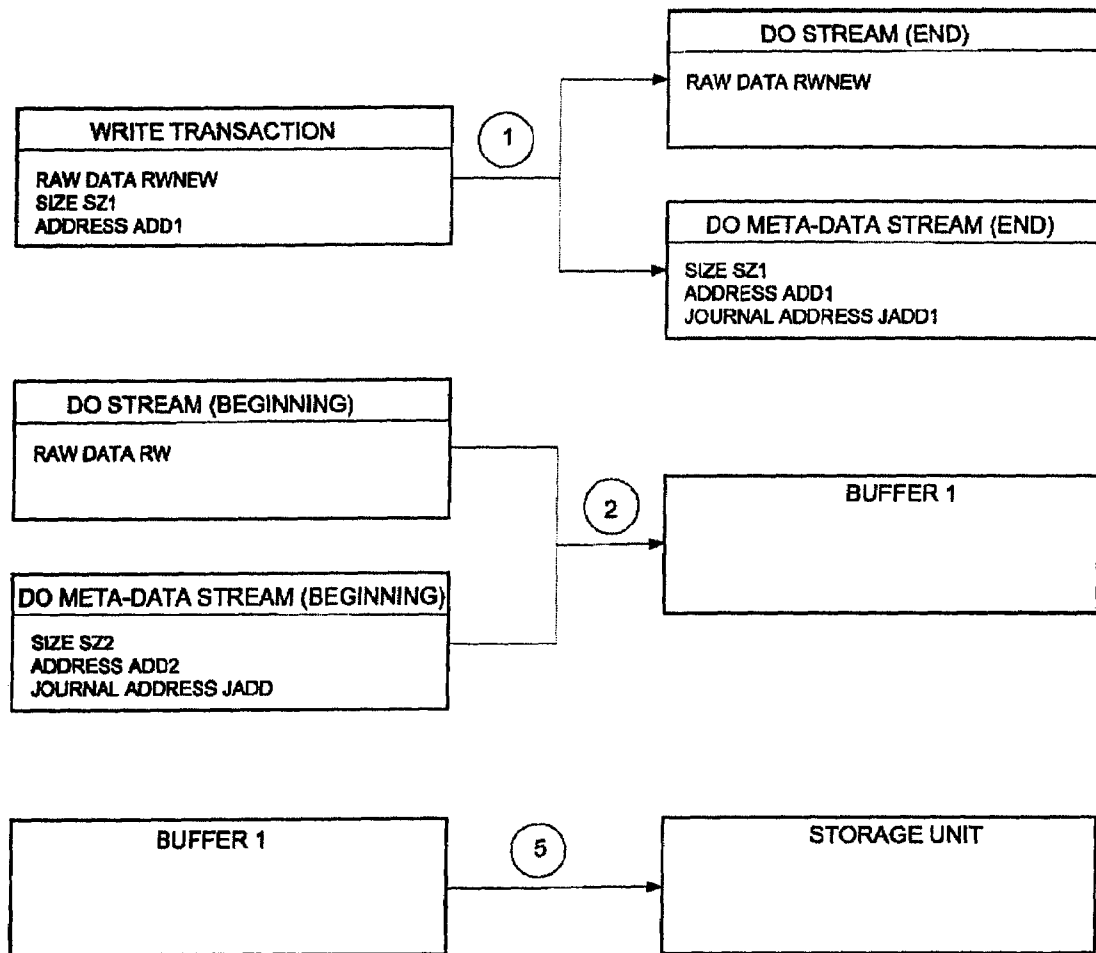

FIG. 10

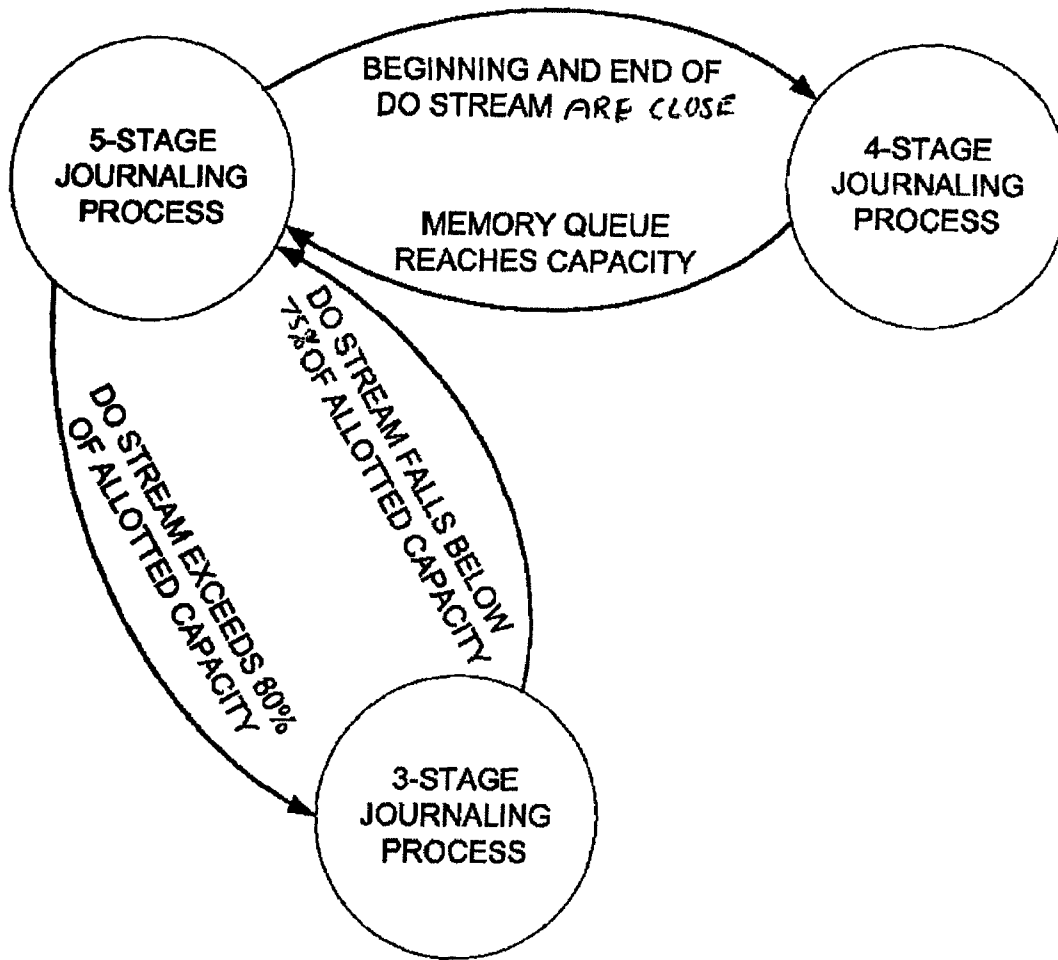

FIG. 11

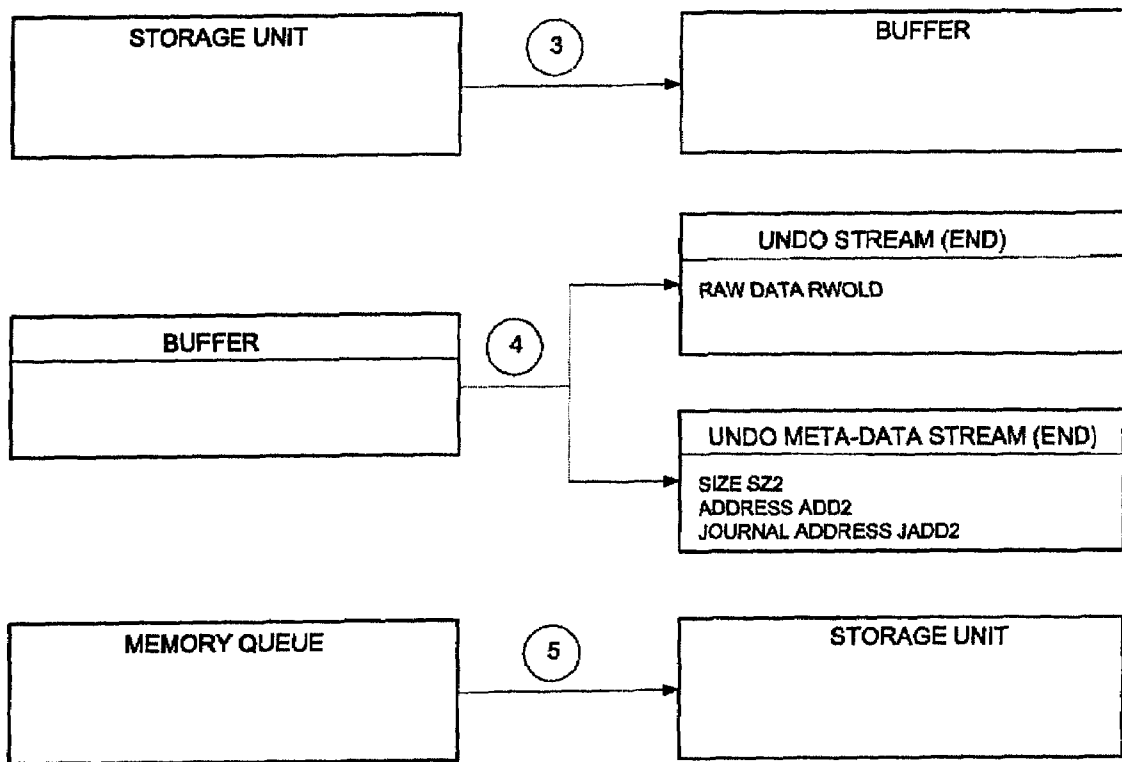

FIG. 12

METHODS AND APPARATUS FOR OPTIMAL JOURNALING FOR CONTINUOUS DATA REPLICATION

BACKGROUND

Computer data is vital to today's organizations, and a significant part of protection against disasters is focused on data protection. As solid-state memory has advanced to the point where cost of memory has become a relatively insignificant factor, organizations can afford to operate with systems that store and process terabytes of data.

Conventional data protection systems include tape backup drives, for storing organizational production site data on a periodic basis. Such systems suffer from several drawbacks. First, they require a system shutdown during backup, since the data being backed up cannot be used during the backup operation. Second, they limit the points in time to which the production site can recover. For example, if data is backed up on a daily basis, there may be several hours of lost data in the event of a disaster. Third, the data recovery process itself takes a long time.

Another conventional data protection system uses data replication, by creating a copy of the organization's production site data on a secondary backup storage system, and updating the backup with changes. The backup storage system may be situated in the same physical location as the production storage system, or in a physically remote location. Data replication systems generally operate either at the application level, at the file system level, or at the data block level.

Current data protection systems try to provide continuous data protection, which enable the organization to roll back to any specified point in time within a recent history. Continuous data protection systems aim to satisfy two conflicting objectives, as best as possible; namely, (i) minimize the down time, in which the organization production site data is unavailable, during a recovery, and (ii) enable recovery as close as possible to any specified point in time within a recent history.

Continuous data protection typically uses a technology referred to as "journaling," whereby a log is kept of changes made to the backup storage. During a recovery, the journal entries serve as successive "undo" information, enabling roll-back of the backup storage to previous points in time. Journaling was first implemented in database systems, and was later extended to broader data protection.

One challenge to continuous data protection is the ability of a backup site to keep pace with the data transactions of a production site, without slowing down the production site. The overhead of journaling inherently requires several data transactions at the backup site for each data transaction at the production site. As such, when data transactions occur at a high rate at the production site, the backup site may not be able to finish backing up one data transaction before the next production site data transaction occurs. If the production site is not forced to slow down, then necessarily a backlog of un-logged data transactions may build up at the backup site. Without being able to satisfactorily adapt dynamically to changing data transaction rates, a continuous data protection system chokes and eventually forces the production site to shut down.

SUMMARY

The present invention concerns methods and systems for providing continuous data replication under dynamically changing I/O rates, by implementing an optimized asynchronous journaling policy that adapts dynamically to changing

data transaction rates. A nominal journaling policy operates asynchronously, allowing production site data transactions to proceed prior to completion of logging of previous data transactions. The nominal journaling policy changes to an accelerated policy when a backlog of data transactions exceeds a predetermined size, and changes back to the nominal policy when the backlog is suitably relieved. The nominal journaling policy includes five stages of I/O, and the accelerated journal policy omits two of the five stages.

In addition, the present invention uses a near real-time journaling policy, when the data transaction rate at the production site is slow enough to enable the backup site to keep pace without need for a journal backlog buffer. The near real-time policy is used until the data transaction rate increases to the point that the journal backlog buffer is necessary.

There is thus provided in accordance with an embodiment of the present invention a method for continuous data replication, including receiving a write transaction from a production site, the write transaction including raw data, designated RWNEW, a size indicator for the size of the raw data, designated SZ1, and a start address for writing the raw data, designated ADD1, copying raw data RWNEW into a first journal data stream, starting at a current journal address, designated JADD1, and copying size indicator SZ1, start address ADD1 and journal address JADD1 into a first journal meta-data stream, at the end of the first journal meta-data stream.

There is moreover provided in accordance with an embodiment of the present invention a method for continuous data replication, including receiving a write transaction from a production site, the write transaction including raw data, designated RWNEW, a size indicator for the size of the raw data, designated SZ, and a start address for writing the raw data, designated ADD, reading raw data, designated RWOLD, from a storage unit beginning at start address ADD and extending to the size of size indicator SZ, copying raw data RWOLD to a journal data stream at a current journal address, designated JADD, copying size indicator SZ, start address ADD, and journal address JADD into a journal meta-data stream, at the end of the journal meta-data stream, and copying raw data RWNEW to the storage unit, beginning at start address ADD.

There is further provided in accordance with an embodiment of the present invention a method for continuous data replication, including receiving a plurality of write transactions from a production site, each write transaction including raw data, designated RWNEW, a size indicator for the size of the raw data, designated SZ1, and a start address for writing the raw data, designated ADD1, if the plurality of write transactions are received at a high I/O rate, then copying raw data RWNEW into a first journal data stream, starting at a current journal address, designated JADD1, and copying size indicator SZ1, start address ADD1 and journal address JADD1 into a first journal meta-data stream, at the end of the first journal meta-data stream, else reading raw data, designated RWOLD, from a storage unit beginning at start address ADD1 and extending to the size of size indicator SZ1, copying raw data RWOLD to a second journal data stream at a current journal address, designated JADD2, copying size indicator SZ1, start address ADD1, and journal address JADD2 into a second journal meta-data stream, at the end of the second journal meta-data stream, and copying raw data RWNEW to the storage unit, beginning at start address ADD1.

There is yet further provided in accordance with an embodiment of the present invention a computer-readable storage medium storing program code for causing a computing device to receive a write transaction from a production

site, the write transaction including raw data, designated RNEW, a size indicator for the size of the raw data, designated SZ1, and a start address for writing the raw data, designated ADD1, copy raw data RNEW into a first journal data stream, starting at a current journal address, designated JADD1, and copy size indicator SZ1, start address ADD1 and journal address JADD1 into a first journal meta-data stream, at the end of the first journal meta-data stream.

There is additionally provided in accordance with an embodiment of the present invention a computer-readable storage medium storing program code for causing a computing device to receive a write transaction from a production site, the write transaction including raw data, designated RNEW, a size indicator for the size of the raw data, designated SZ, and a start address for writing the raw data, designated ADD, read raw data, designated RWOLD, from a storage unit beginning at start address ADD and extending to the size of size indicator SZ, copy raw data RWOLD to a journal data stream at a current journal address, designated JADD, copy size indicator SZ, start address ADD, and journal address JADD into a journal meta-data stream, at the end of the journal meta-data stream, and copy raw data RNEW to the storage unit, beginning at start address ADD.

There is moreover provided in accordance with an embodiment of the present invention a computer-readable storage medium storing program code for causing a computing device to receive a plurality of write transactions from a production site, each write transaction including raw data, designated RNEW, a size indicator for the size of the raw data, designated SZ1, and a start address for writing the raw data, designated ADD1, if the plurality of write transactions are received at a high I/O rate, then copy raw data RNEW into a first journal data stream, starting at a current journal address, designated JADD1, and copy size indicator SZ1, start address ADD1 and journal address JADD1 into a first journal meta-data stream, at the end of the first journal meta-data stream, else read raw data, designated RWOLD, from a storage unit beginning at start address ADD1 and extending to the size of size indicator SZ1, copy raw data RWOLD to a second journal data stream at a current journal address, designated JADD2, copy size indicator SZ1, start address ADD1, and journal address JADD2 into a second journal meta-data stream, at the end of the second journal meta-data stream, and copy raw data RNEW to the storage unit, beginning at start address ADD1.

There is further provided in accordance with an embodiment of the present invention a method for continuous data replication, including receiving a plurality of write transactions from a data production site, for application at a data backup site, dynamically selecting one of a plurality of journaling processes based on at least one processing state transition rule, wherein each of the plurality of journaling processes controls the queuing, recording and application of write transactions received at the backup site, and wherein each of the at least one processing state transition rule relates directly or indirectly to rates of incoming write transactions at the data backup site, temporarily queuing write transactions at the backup site within a queue, in accordance with the selected journaling process, recording write transactions at the backup site, for data recovery purposes, in accordance with the selected journaling process, and applying the write transactions at the backup site, in accordance with the selected journaling process.

There is yet further provided in accordance with an embodiment of the present invention a system for continuous data replication, including a receiver for receiving a plurality of write transactions from a data production site, for applica-

tion at a data backup site, a state machine for dynamically selecting one of a plurality of journaling processes based on at least one processing state transition rule, wherein each of the plurality of journaling processes controls the queuing, recording and application of write transactions received at the backup site, and wherein each of the at least one processing state transition rule relates directly or indirectly to rates of incoming write transactions at the data backup site, a queue manager coupled with the receiver and the state machine for temporarily queuing write transactions at the backup site within a queue until they can be applied, in accordance with the selected journaling process, and a memory manager coupled with the receiver and the state machine for recording write transactions at the backup site, for data recovery purposes, in accordance with the selected journaling process, and a storage manager coupled with the receiver and the state machine for applying the write transactions at the backup site, in accordance with the selected journaling process.

There is additionally provided in accordance with an embodiment of the present invention a computer-readable storage medium storing program code for causing a computing device to receive a plurality of write transactions from a data production site, for application at a data backup site, select one of a plurality of journaling processes based on at least one processing state transition rule, wherein each of the plurality of journaling processes controls the queuing, recording and application of write transactions received at the backup site, and wherein each of the at least one processing state transition rule relates directly or indirectly to rates of incoming write transactions at the data backup site, temporarily queue write transactions at the backup site within a queue, in accordance with the selected journaling process, record write transactions at the backup site, for data recovery purposes, in accordance with the selected journaling process, and apply the write transactions at the backup site, in accordance with the selected journaling process.

The following definitions are employed throughout the specification and claims.

BACKUP SITE—a facility where replicated production site data is stored; the backup site may be located in a remote site or at the same location as the production site;

DPA—a computer or a cluster of computers that serve as a data protection appliance, responsible for data protection services including inter alia data replication of a storage system, and journaling of I/O requests issued by a host computer to the storage system;

HOST—at least one computer or networks of computers that runs at least one data processing application that issues I/O requests to one or more storage systems; a host is an initiator with a SAN;

HOST DEVICE—an internal interface in a host, to a logical storage unit;

IMAGE—a copy of a logical storage unit at a specific point in time;

INITIATOR—a node in a SAN that issues I/O requests;

JOURNAL—a record of write transactions issued to a storage system; used to maintain a duplicate storage system, and to rollback the duplicate storage system to a previous point in time;

LOGICAL UNIT—a logical entity provided by a storage system for accessing data from the storage system;

LUN—a logical unit number for identifying a logical unit;

PHYSICAL STORAGE UNIT—a physical entity, such as a disk or an array of disks, for storing data in storage locations that can be accessed by address;

5

PRODUCTION SITE—a facility where one or more host computers run data processing applications that write data to a storage system and read data from the storage system;

SAN—a storage area network of nodes that send and receive I/O and other requests, each node in the network being an initiator or a target, or both an initiator and a target;

SOURCE SIDE—a transmitter of data within a data replication workflow, during normal operation a production site is the source side; and during data recovery a backup site is the source side;

STORAGE SYSTEM—a SAN entity that provides multiple logical units for access by multiple SAN initiators

TARGET—a node in a SAN that replies to I/O requests;

TARGET SIDE—a receiver of data within a data replication workflow; during normal operation a back site is the target side, and during data recovery a production site is the target side;

WAN—a wide area network that connects local networks and enables them to communicate with one another, such as the Internet.

BRIEF DESCRIPTION OF THE DRAWINGS

The present invention will be more fully understood and appreciated from the following detailed description, taken in conjunction with the drawings in which:

FIG. 1 is a simplified block diagram of a data protection system, in accordance with an embodiment of the present invention;

FIG. 2 is a simplified illustration of a journal history of write transactions for a storage system, in accordance with an embodiment of the present invention;

FIG. 3A is a simplified illustration of a first stage of a journal and four data streams stored therein, after recording three write transactions, in accordance with an embodiment of the present invention;

FIG. 3B is a simplified illustration of a second stage of a journal and four data streams stored therein, after applying a first write transactions to a storage system, in accordance with an embodiment of the present invention;

FIG. 3C is a simplified illustration of a third stage of a journal history and four data streams stored therein, after applying a second write transactions to a storage system, in accordance with an embodiment of the present invention;

FIG. 3D is a simplified illustration of a fourth stage of a journal history and four data streams stored therein, after rolling back a write transaction, in accordance with an embodiment of the present invention;

FIG. 4 is a simplified flowchart of a data protection method during a normal production mode, in accordance with an embodiment of the present invention;

FIG. 5 is a simplified flowchart of a data protection method during a data recovery mode, prior to completion of rollback, in accordance with an embodiment of the present invention;

FIG. 6 is a simplified flowchart of a data protection method during a data recovery mode, after completion of rollback, in accordance with an embodiment of the present invention;

FIG. 7 is a simplified illustration of a time-line for tracking new processing of old data, in accordance with an embodiment of the present invention;

FIG. 8 is a simplified illustration of a five-stage journaling process for continuous data replication, in accordance with an embodiment of the present invention;

FIG. 9 is a simplified illustration of a four-stage journaling process for continuous data replication, for use when an I/O data rate is low, in accordance with an embodiment of the present invention;

6

FIG. 10 is a simplified illustration of a three-stage journaling process for continuous data replication, for use when an I/O data rate is high, in accordance with an embodiment of the present invention;

FIG. 11 is a simplified state diagram of transitions between 5-stage, 4-stage and 3-stage journal processing, in accordance with an embodiment of the present invention; and

FIG. 12 is a simplified illustration of a variant of the three-stage journaling process shown in FIG. 10, which may be used in an alternative embodiment of the present invention.

DETAILED DESCRIPTION

Reference is now made to FIG. 1, which is a simplified illustration of a data protection system 100, in accordance with an embodiment of the present invention. Shown in FIG. 1 are two sites; Site I, which is a production site, on the right, and Site II, which is a backup site, on the left. Under normal operation the production site is the source side of system 100, and the backup site is the target side of the system. The backup site is responsible for replicating production site data. Additionally, the backup site enables rollback of Site I data to an earlier pointing time, which may be used in the event of data corruption of a disaster, or alternatively in order to view or to access data from an earlier point in time.

During normal operations, the direction of replicate data flow goes from source side to target side. It is possible, however, for a user to reverse the direction of replicate data flow, in which case Site I starts to behave as a target backup site, and Site II starts to behave as a source production site. Such change of replication direction is referred to as a “failover”. A failover may be performed in the event of a disaster at the production site, or for other reasons. In some data architectures, Site I or Site II behaves as a production site for a portion of stored data, and behaves simultaneously as a backup site for another portion of stored data. In some data architectures, a portion of stored data is replicated to a backup site, and another portion is not.

The production site and the backup site may be remote from one another, or they may both be situated at a common site, local to one another. Local data protection has the advantage of minimizing data lag between target and source, and remote data protection has the advantage of being robust in the event that a disaster occurs at the source side.

The source and target sides communicate via a wide area network (WAN) 128, although other types of networks are also adaptable for use with the present invention.

In accordance with an embodiment of the present invention, each side of system 100 includes three major components coupled via a storage area network (SAN); namely, (i) a storage system, (ii) a host computer, and (iii) a data protection appliance (DPA). Specifically with reference to FIG. 1, the source side SAN includes a source host computer 104, a source storage system 108, and a source DPA 112. Similarly, the target side SAN includes a target host computer 116, a target storage system 120, and a target DPA 124.

Generally, a SAN includes one or more devices, referred to as “nodes”. A node in a SAN may be an “initiator” or a “target”, or both. An initiator node is a device that is able to initiate requests to one or more other devices; and a target node is a device that is able to reply to requests, such as SCSI commands, sent by an initiator node. A SAN may also include network switches, such as fiber channel switches. The communication links between each host computer and its corresponding storage system may be any appropriate medium suitable for data transfer, such as fiber communication channel links.

In an embodiment of the present invention, the host communicates with its corresponding storage system using small computer system interface (SCSI) commands.

System 100 includes source storage system 108 and target storage system 120. Each storage system includes physical storage units for storing data, such as disks or arrays of disks. Typically, storage systems 108 and 120 are target nodes. In order to enable initiators to send requests to storage system 108, storage system 108 exposes one or more logical units (LU) to which commands are issued. Thus, storage systems 108 and 120 are SAN entities that provide multiple logical units for access by multiple SAN initiators.

Logical units are a logical entity provided by a storage system, for accessing data stored in the storage system. A logical unit is identified by a unique logical unit number (LUN). In an embodiment of the present invention, storage system 108 exposes a logical unit 136, designated as LU A, and storage system 120 exposes a logical unit 156, designated as LU B.

In an embodiment of the present invention, LU B is used for replicating LU A. As such, LU B is generated as a copy of LU A. In one embodiment, LU B is configured so that its size is identical to the size of LU A. Thus for LU A, storage system 120 serves as a backup for source side storage system 108. Alternatively, as mentioned hereinabove, some logical units of storage system 120 may be used to back up logical units of storage system 108, and other logical units of storage system 120 may be used for other purposes. Moreover, in certain embodiments of the present invention, there is symmetric replication whereby some logical units of storage system 108 are used for replicating logical units of storage system 120, and other logical units of storage system 120 are used for replicating other logical units of storage system 108.

System 100 includes a source side host computer 104 and a target side host computer 116. A host computer may be one computer, or a plurality of computers, or a network of distributed computers, each computer may include inter alia a conventional CPU, volatile and non-volatile memory, a data bus, an I/O interface, a display interface and a network interface. Generally a host computer runs at least one data processing application, such as a database application and an e-mail server.

Generally, an operating system of a host computer creates a host device for each logical unit exposed by a storage system in the host computer SAN. A host device is a logical entity in a host computer, through which a host computer may access a logical unit. In an embodiment of the present invention, host device 104 identifies LU A and generates a corresponding host device 140, designated as Device A, through which it can access LU A. Similarly, host computer 116 identifies LU B and generates a corresponding device 160, designated as Device B.

In an embodiment of the present invention, in the course of continuous operation, host computer 104 is a SAN initiator that issues I/O requests (write/read operations) through host device 140 to LU A using, for example, SCSI commands. Such requests are generally transmitted to LU A with an address that includes a specific device identifier, an offset within the device, and a data size. Offsets are generally aligned to 512 byte blocks. The average size of a write operation issued by host computer 104 may be, for example, 10 kilobytes (KB); i.e., 20 blocks. For an I/O rate of 50 megabytes (MB) per second, this corresponds to approximately 5,000 write transactions per second.

System 100 includes two data protection appliances, a source side DPA 112 and a target side DPA 124. A DPA performs various data protection services, such as data repli-

cation of a storage system, and journaling of I/O requests issued by a host computer to source side storage system data. As explained in detail hereinbelow, when acting as a target side DPA, a DPA may also enable rollback of data to an earlier point in time, and processing of rolled back data at the target site. Each DPA 112 and 124 is a computer that includes inter alia one or more conventional CPUs and internal memory.

For additional safety precaution, each DPA is a cluster of such computers. Use of a cluster ensures that if a DPA computer is down, then the DPA functionality switches over to another computer. The DPA computers within a DPA cluster communicate with one another using at least one communication link suitable for data transfer via fiber channel or IP based protocols, or such other transfer protocol. One computer from the DPA cluster serves as the DPA leader. The DPA cluster leader coordinates between the computers in the cluster, and may also perform other tasks that require coordination between the computers, such as load balancing.

In the architecture illustrated in FIG. 1, DPA 112 and DPA 124 are standalone devices integrated within a SAN. Alternatively, each of DPA 112 and DPA 124 may be integrated into storage system 108 and storage system 120, respectively, or integrated into host computer 104 and host computer 116, respectively. Both DPAs communicate with their respective host computers through communication lines such as fiber channels using, for example, SCSI commands.

In accordance with an embodiment of the present invention, DPAs 112 and 124 are configured to act as initiators in the SAN; i.e., they can issue I/O requests using, for example, SCSI commands, to access logical units on their respective storage systems. DPA 112 and DPA 124 are also configured with the necessary functionality to act as targets; i.e., to reply to I/O requests, such as SCSI commands, issued by other initiators in the SAN, including inter alia their respective host computers 104 and 116. Being target nodes, DPA 112 and DPA 124 may dynamically expose or remove one or more logical units.

As described hereinabove, Site I and Site II may each behave simultaneously as a production site and a backup site for different logical units. As such, DPA 112 and DPA 124 may each behave as a source DPA for some logical units, and as a target DPA for other logical units, at the same time.

In accordance with an embodiment of the present invention, host computer 104 and host computer 116 include protection agents 144 and 164, respectively. Protection agents 144 and 164 intercept SCSI commands issued by their respective host computers, via host devices to logical units that are accessible to the host computers. In accordance with an embodiment of the present invention, a data protection agent may act on an intercepted SCSI commands issued to a logical unit, in one of the following ways:

Send the SCSI commands to its intended logical unit.

Redirect the SCSI command to another logical unit.

Split the SCSI command by sending it first to the respective DPA. After the DPA returns an acknowledgement, send the SCSI command to its intended logical unit.

Fail a SCSI command by returning an error return code.

Delay a SCSI command by not returning an acknowledgement to the respective host computer.

A protection agent may handle different SCSI commands, differently, according to the type of the command. For example, a SCSI command inquiring about the size of a certain logical unit may be sent directly to that logical unit, while a SCSI write command may be split and sent first to a DPA associated with the agent. A protection agent may also change its behavior for handling SCSI commands, for example as a result of an instruction received from the DPA.

Specifically, the behavior of a protection agent for a certain host device generally corresponds to the behavior of its associated DPA with respect to the logical unit of the host device. When a DPA behaves as a source site DPA for a certain logical unit, then during normal course of operation, the associated protection agent splits I/O requests issued by a host computer to the host device corresponding to that logical unit. Similarly, when a DPA behaves as a target device for a certain logical unit, then during normal course of operation, the associated protection agent fails I/O requests issued by host computer to the host device corresponding to that logical unit.

Communication between protection agents and their respective DPAs may use any protocol suitable for data transfer within a SAN, such as fiber channel, or SCSI over fiber channel. The communication may be direct, or via a logical unit exposed by the DPA. In an embodiment of the present invention, protection agents communicate with their respective DPAs by sending SCSI commands over fiber channel.

In an embodiment of the present invention, protection agents **144** and **164** are drivers located in their respective host computers **104** and **116**. Alternatively, a protection agent may also be located in a fiber channel switch, or in any other device situated in a data path between a host computer and a storage system.

What follows is a detailed description of system behavior under normal production mode, and under recovery mode.

In accordance with an embodiment of the present invention, in production mode DPA **112** acts as a source site DPA for LU A. Thus, protection agent **144** is configured to act as a source side protection agent; i.e., as a splitter for host device A. Specifically, protection agent **144** replicates SCSI I/O requests. A replicated SCSI I/O request is sent to DPA **112**. After receiving an acknowledgement from DPA **124**, protection agent **144** then sends the SCSI I/O request to LU A. Only after receiving a second acknowledgement from storage system **108** will host computer **104** initiate another I/O request.

When DPA **112** receives a replicated SCSI write request from data protection agent **144**, DPA **112** transmits certain I/O information characterizing the write request, packaged as a "write transaction", over WAN **128** to DPA **124** on the target side, for journaling and for incorporation within target storage system **120**.

DPA **112** may send its write transactions to DPA **124** using a variety of modes of transmission, including inter alia (i) a synchronous mode, (ii) an asynchronous mode, and (iii) a snapshot mode. In synchronous mode, DPA **112** sends each write transaction to DPA **124**, receives back an acknowledgement from DPA **124**, and in turns sends an acknowledgement back to protection agent **144**. Protection agent **144** waits until receipt of such acknowledgement before sending the SCSI write request to LU A.

In asynchronous mode, DPA **112** sends an acknowledgement to protection agent **144** upon receipt of each I/O request, before receiving an acknowledgement back from DPA **124**.

In snapshot mode, DPA **112** receives several I/O requests and combines them into an aggregate "snapshot" of all write activity performed in the multiple I/O requests, and sends the snapshot to DPA **124**, for journaling and for incorporation in target storage system **120**. In snapshot mode DPA **112** also sends an acknowledgement to protection agent **144** upon receipt of each I/O request, before receiving an acknowledgement back from DPA **124**.

For the sake of clarity, the ensuing discussion assumes that information is transmitted at write-by-write granularity.

While in production mode, DPA **124** receives replicated data of LU A from DPA **112**, and performs journaling and writing to storage system **120**. When applying write opera-

tions to storage system **120**, DPA **124** acts as an initiator, and sends SCSI commands to LU B.

During a recovery mode, DPA **124** undoes the write transactions in the journal, so as to restore storage system **120** to the state it was at, at an earlier time.

As described hereinabove, in accordance with an embodiment of the present invention, LU B is used as a backup of LU A. As such, during normal production mode, while data written to LU A by host computer **104** is replicated from LU A to LU B, host computer **116** should not be sending I/O requests to LU B. To prevent such I/O requests from being sent, protection agent **164** acts as a target site protection agent for host Device B and fails I/O requests sent from host computer **116** to LU B through host Device B.

In accordance with an embodiment of the present invention, target storage system **120** exposes a logical unit **176**, referred to as a "journal LU", for maintaining a history of write transactions made to LU B, referred to as a "journal". Alternatively, journal LU **176** may be striped over several logical units, or may reside within all of or a portion of another logical unit. DPA **124** includes a journal processor **180** for managing the journal.

Journal processor **180** functions generally to manage the journal entries of LU B. Specifically, journal processor **180** (i) enters write transactions received by DPA **124** from DPA **112** into the journal, by writing them into the journal LU, (ii) applies the journal transactions to LU B, and (iii) updates the journal entries in the journal LU with undo information and removes already-applied transactions from the journal. As described below, with reference to FIGS. **2** and **3A-3D**, journal entries include four streams, two of which are written when write transaction are entered into the journal, and two of which are written when write transaction are applied and removed from the journal.

Reference is now made to FIG. **2**, which is a simplified illustration of a write transaction **200** for a journal, in accordance with an embodiment of the present invention. The journal may be used to provide an adaptor for access to storage **120** at the state it was in at any specified point in time. Since the journal contains the "undo" information necessary to rollback storage system **120**, data that was stored in specific memory locations at the specified point in time may be obtained by undoing write transactions that occurred subsequent to such point in time.

Write transaction **200** generally includes the following fields:

- one or more identifiers;
- a time stamp, which is the date & time at which the transaction was received by source side DPA **112**;
- a write size, which is the size of the data block;
- a location in journal LU **176** where the data is entered;
- a location in LU B where the data is to be written; and
- the data itself.

Write transaction **200** is transmitted from source side DPA **112** to target side DPA **124**. As shown in FIG. **2**, DPA **124** records the write transaction **200** in four streams. A first stream, referred to as a DO stream, includes new data for writing in LU B. A second stream, referred to as an DO METADATA stream, includes metadata for the write transaction, such as an identifier, a date & time, a write size, a beginning address in LU B for writing the new data in, and a pointer to the offset in the do stream where the corresponding data is located. Similarly, a third stream, referred to as an UNDO stream, includes old data that was overwritten in LU B; and a fourth stream, referred to as an UNDO METADATA, include an identifier, a date & time, a write size, a beginning

address in LU B where data was to be overwritten, and a pointer to the offset in the undo stream where the corresponding old data is located.

In practice each of the four streams holds a plurality of write transaction data. As write transactions are received dynamically by target DPA 124, they are recorded at the end of the DO stream and the end of the DO METADATA stream, prior to committing the transaction. During transaction application, when the various write transactions are applied to LU B, prior to writing the new DO data into addresses within the storage system, the older data currently located in such addresses is recorded into the UNDO stream.

By recording old data, a journal entry can be used to “undo” a write transaction. To undo a transaction, old data is read from the UNDO stream in a reverse order, from the most recent data to the oldest data, for writing into addresses within LU B. Prior to writing the UNDO data into these addresses, the newer data residing in such addresses is recorded in the DO stream.

The journal LU is partitioned into segments with a pre-defined size, such as 1 MB segments, with each segment identified by a counter. The collection of such segments forms a segment pool for the four journaling streams described hereinabove. Each such stream is structured as an ordered list of segments, into which the stream data is written, and includes two pointers—a beginning pointer that points to the first segment in the list and an end pointer that points to the last segment in the list.

According to a write direction for each stream, write transaction data is appended to the stream either at the end, for a forward direction, or at the beginning, for a backward direction. As each write transaction is received by DPA 124, its size is checked to determine if it can fit within available segments. If not, then one or more segments are chosen from the segment pool and appended to the stream’s ordered list of segments.

Thereafter the DO data is written into the DO stream, and the pointer to the appropriate first or last segment is updated. Freeing of segments in the ordered list is performed by simply changing the beginning or the end pointer. Freed segments are returned to the segment pool for re-use.

When a write transaction is received, journaling is thus advanced as indicated in TABLE I below.

TABLE I

Entering a write transaction in the journal	
Step 1	The new data is written at the end of the DO stream, assuming a forward write direction, and corresponding metadata is written at the end of the DO METADATA stream.
Step 2	Data is read from the beginning of the DO stream, and corresponding metadata is read from the beginning of the DO METADATA stream.
Step 3	Old data to be overwritten is read from LU B. The location and size of such old data is determined from the DO METADATA stream.
Step 4	The old data is written at the end of the UNDO stream, and corresponding metadata is written at the end of the UNDO METADATA stream.
Step 5	The new data read at Step 2 is written into LU B, and the beginning and end pointers of the DO and DO METADATA streams are moved appropriately.

Conversely, during a rollback to undo a write transaction, the above operations are reversed, as indicated in TABLE II below.

TABLE II

Undoing a write transaction in the journal	
Step 1	Read the data and metadata from the end of the UNDO and UNDO METADATA streams.
Step 2	Read from LU B the data that is to be overwritten. The location and size of such data is determined from the UNDO METADATA stream.
Step 3	Write the data from Step 2 at the beginning of the DO stream, and update the DO METADATA stream accordingly.
Step 4	Write the data from Step 1 to LU B, and update the beginning and end pointers of the UNDO and UNDO metadata streams appropriately.

The following example, in conjunction with FIGS. 3A-3D, describes specific details of the journaling process, in accordance with an embodiment of the present invention. A journal volume includes a plurality of segments from a segment pool, each segment including 20 data blocks.

Three write transactions are received, as indicated in TABLE III.

TABLE III

Example Write Transactions				
Write ID	Time	LU B location	Length	Journal LU location
1	Dec. 3, 2005 10:00:00.00	LU B offset 57 blocks	15 blocks	Segment 1, offset 0
2	Dec. 3, 2005 10:00:00.05	LU B offset 87 blocks	20 blocks	Segment 1, offset 15
3	Dec. 3, 2005 10:00:00.18	LU B offset 12 blocks	20 blocks	Segment 3, Offset 15

The following discussion describes four stages of journaling and data storage; namely,

Stage #1: Enter the three write transactions as journal entries in the journal LU.

Stage #2: Apply the first write transaction to LU B.

Stage #3: Apply the second write transaction to LU B.

Stage #4: Rollback the second write transaction, to recover data from an earlier point in time.

The write transaction with ID=1 is written to the first 15 blocks of Segment #1. The metadata corresponding to this transaction is written to the first block of Segment #2. The second write transaction with ID=2 is written to the last 5 blocks of Segment #1 and the first 15 blocks of Segment #3. The metadata corresponding to this transaction is written to the second block of Segment #2. The third write transaction with ID=3 is written to the last 5 blocks of Segment #3 and the first 15 blocks of Segment #4. The metadata corresponding to this transaction is written to the third block of Segment #2.

Thus at stage #1, the DO stream in memory includes a list of segments 1, 3, 4; and a beginning pointer to offset=0 in Segment #1 and an end pointer to offset=10 in Segment #4. The DO METADATA stream in memory includes a list of one segment, namely Segment #2; and a beginning pointer to offset=0 in Segment #2 and an end pointer to offset=3 in Segment #2. The UNDO stream and the UNDO METADATA stream are empty. The journal and the four streams at the end of stage #1 are illustrated in FIG. 3A.

At stage #2 the write transaction with ID=1 is applied to LU B. New data to be written is read from the journal LU at the offset and length indicated in the DO METADATA; namely, 15 blocks of data located in blocks 0-14 of journal volume Segment #1. Correspondingly, old data is read from LU B at

the offset and length indicated in the UNDO METADATA; namely, 15 blocks of data located in blocks 57-71 of LU B. The old data is then written into the UNDO stream in the journal LU, and the associated metadata is written into the UNDO METADATA stream in the journal LU. Specifically, for this example, the UNDO data is written into the first 15 blocks of Segment #5, and the UNDO METADATA is written into the first block of Segment #6. The beginning pointer of the UNDO data stream is set to offset=0 in Segment #5, and the end pointer is set to offset=15 in Segment #5. Similarly, the beginning pointer of the UNDO METADATA stream is set to offset=0 on Segment #6, and the end pointer is set to offset=1 in Segment #6.

At this point, the new data that was read from blocks 0-14 of journal LU Segment #1 is written to blocks 57-71 of LU B. The beginning pointer for the DO stream is moved forward to block 15 of journal LU Segment #1, and the beginning pointer for the DO METADATA stream is moved forward to block 1 of journal LU Segment #2. The journal and the four streams at the end of stage #2 are illustrated in FIG. 3B.

At stage #3 the write transaction with ID=2 is applied to the storage system. As above, 20 blocks of new data are read from blocks 15-19 of journal LU Segment #1 and from blocks 0-14 of journal LU Segment #3. Similarly, 20 blocks of old data are read from blocks 87-106 of LU B. The old data is written to the UNDO stream in the last 5 blocks of journal LU Segment #5 and the first 15 blocks of journal LU Segment #7. The associated metadata is written to the UNDO METADATA stream in the second block of Segment #6. The list of segments in the UNDO stream includes Segment #5 and Segment #7. The end pointer of the UNDO stream is moved to block 15 of Segment #7, and the end pointer of the UNDO METADATA stream is moved to block 2 of Segment #6.

Finally, the new data from blocks 15-19 of journal LU Segment #1 and blocks 0-14 of journal LU Segment #3 is written into blocks 87-106 of LU B. The beginning pointer for the DO stream is moved forward to block 15 of journal volume Segment #3, and the beginning pointer for the DO METADATA stream is moved forward to block 2 of journal LU Segment #2. Segment #1 is freed from the DO stream, for recycling within the segment pool, and the list of segments for the DO stream is changed to Segment #3 and Segment #4. The journal and the four streams at the end of stage #3 are illustrated in FIG. 3C.

At stage #4 a rollback to time 10:00:00.00 is performed. Since the write transaction with ID=3 was not applied yet, the only write transaction to be undone is the write transaction with ID=2. The last entry is read from the UNDO METADATA stream, the location of the end of the UNDO METADATA stream being determined by its end pointer, i.e., the metadata before block 2 of journal LU Segment #6 is read, indicating two areas each of 20 blocks; namely, (a) the last 5 blocks of journal LU Segment #5 and the first 15 blocks of journal LU Segment #7, and (b) blocks 87-106 of LU B. Area (a) is part of the UNDO stream.

The 20 blocks of data from area (b) are read from LU B and written to the beginning of the DO stream. As the beginning pointer of the DO stream is set to offset=15 of journal LU Segment #3, 5 blocks are written at the end of Segment #3, and the remaining 15 blocks are written to Segment #8. The end pointer for the DO stream is set to block 15 of Segment #8. The list of segments for the DO stream is changed to Segment #3, Segment #4 and Segment #8. The metadata associated with the 20 blocks from area (b) is written to block 3 of Segment #2, and the end pointer of the DO METADATA stream is advanced to block 4 of Segment #2.

The 20 blocks of data in area (a) of the journal LU are then written to area (b) of the LU B. Finally, Segment #7 is freed for recycling in the segment pool, the UNDO stream ending pointer is moved back to Segment #5 of the journal LU, block 15, and the UNDO METADATA stream ending pointer is moved back to Segment #6 of the journal LU, block 1. The journal and the four streams at the end of stage #4 are illustrated in FIG. 3D.

Thus it may be appreciated that the journal is thus used to rollback LU B to the state that it was in at a previous point in time. The journal is also used to selectively access data from LU B at such previous point in time, without necessarily performing a rollback. Selective access is useful for correcting one or more files that are currently corrupt, or for simply accessing old data.

TABLE IV below summarizes the behavior of the special protection components of system 100 during production mode. Reference is also made to FIG. 4, which is a simplified flowchart of a data protection method corresponding to TABLE IV. FIG. 4 is divided into four columns. The leftmost column indicates steps performed by source side protection agent 112, the middle left column indicates steps performed by source side DPA 144, the middle right column indicates steps performed by target side DPA 124, and the rightmost column indicates steps performed by target side protection agent 164.

TABLE IV

Normal Production Mode Functionality	
System Component	Behavior
Source Side Agent 144	Intercept SCSI commands issued to LU A by source side host via Device A (step 404). Replicate write commands, and route write commands to DPA (steps 408 and 412). Wait for first acknowledgement, from DPA (step 416), and then route replicate I/O command to LU A (step 420). Wait for second acknowledgement, from storage system (step 424), and then process next intercepted SCSI command (step 404).
Source Side DPA 112	Receive write command from agent (step 428). Format write command as write transaction, and send to target DPA (step 428). In synchronous mode, wait for acknowledgement from target DPA (step 432), and then send acknowledgement to agent (step 436). In asynchronous mode and in snapshot mode, send acknowledgement to agent without waiting for acknowledgement from target DPA (step 436).
Target Side DPA 124	Receive write transaction from source DPA (step 444). Enter write transaction in journal DO and DO METADATA streams (step 444), and send back acknowledgement to source DPA (step 448). Process journal entries by applying them to LU B, and enter undo information in UNDO and UNDO METADATA streams (step 440).
Target Side Agent 164	Fail SCSI commands issued to LU B (step 452).

Only steps with arrows connecting them in FIG. 4 are necessarily sequential. Thus steps 432 and 436, which do not have arrows connecting them, are not necessarily sequential. In synchronous mode these steps are sequential, but in asynchronous mode and in snapshot mode they are not sequential. In particular, DPA 112 may send an acknowledgement to protection agent 144 before receiving an acknowledgement back from DPA 124.

It is also noted in FIG. 4 that the steps performed by target side DPA 124 include two non-sequential groups; namely, (i) step 440, and (ii) steps 444 and 448.

Recovery mode is generally triggered as a result of a disaster at the source side. The source side data may become corrupt, or may not exist at all. In such case, after recovery is completed at the backup site, a user may perform a failover operation by switching the roles of the production site and backup site. The original backup site becomes a current production site, and the original production site becomes a current backup site. Alternatively, recovery mode can be triggered without a failover, in order to access data from a previous point in time.

While in recovery mode, target site DPA 124 continues to receive new write transactions from DPA 112 and enter them at the ends of the DO and DO METADATA streams. However, unlike production mode behavior, DPA 124 stops applying journal entries received from DPA 112 to LU B. Instead, DPA 124 uses the UNDO stream of the journal to rollback LU B, as described hereinabove.

During recovery, after or possibly before rollback of LU B is complete, a user may wish to access data from the target site. To this end, protection agent 164 stops failing I/O requests issued by host computer 160 and begins redirecting them to DPA 124. The processing of data by host computer 160 during recovery mode is referred to as "target side processing (TSP)".

To manage TSP write commands that are received by target side DPA 124, journal processor 180 uses two additional data streams, referred to as TSP DO and TSP METADATA streams. When a TSP write command is received by DPA 124, it is entered at the end of the TSP DO stream and the end of the TSP DO METADATA stream. Since TSP writes relate to the state of LU B after the rollback is complete, the TSP DO stream writes are only applied to LU B after rollback is complete. Journal processor 180 applies TSP writes to LU B in a way similar to the way it applies write transactions deceiver from DPA 112; namely, journal processor 180 maintains the undo information for each write applied to LU B, in TSP UNDO and TSP UNDO METADATA streams.

When TSP read commands are received by target site DPA 124, DPA 124 returns the data to be read by identifying locations of the read command, and finding the most recent TSP write command or commands that were applied at these locations. The data is searched for (i) first in the TSP DO stream, and (ii) then in the journal UNDO data that was not yet applied to LU B and (iii) finally, if the data was not found in (i) and (ii), then the data is taken from LU B itself. In order to perform such a search efficiently, DPA 124 generates and stores in its memory a virtual image of the UNDO METADATA storage locations by using an efficient data structure, such as a binary search tree.

After rollback is completed, the TSP writes that were performed during the rollback are applied to LU B, and DPA 124 begins applying TSP writes synchronously; i.e., TSP writes are applied to LU B when they are received by DPA 124, without keeping them in the TSP DO stream. As such, when a read command is received after rollback is complete, it is sent directly to LU B instead of being redirected through DPA 124.

TABLES V and VI below summarize the behavior of the special protection components of system 100 during recovery mode, before and after the rollback is complete, in accordance with an embodiment of the present invention. Reference is also made to FIGS. 5 and 6, which are simplified flowcharts of data protection methods corresponding to TABLES V and VI, respectively. FIGS. 5 and 6 are divided into four columns. The leftmost column indicates steps performed by target side protection agent 164, the middle left column indicates steps performed by target side DPA 124, the

middle right column indicates steps performed by source side DPA 112, and the rightmost column indicates steps performed by source side protection agent 144.

TABLE V

Recovery Functionality prior to Completion of Rollback	
System Component	Behavior
Target Side Agent 164	Intercept SCSI commands issued to LU B (step 576). Redirect commands to DPA (step 580).
Target Side DPA 124	Use UNDO stream of journal to roll back target storage system (step 540). Continue receiving write transactions from DPA 112 and enter these transactions into DO and DO METADATA streams without applying them to LU B (step 548). Enter TSP write transactions to TSP DO and TSP DO METADATA streams (step 564). Create a virtual image, to reply to read commands issued during the recovery process (step 572).
Source Side DPA 112	As in production mode.
Source Side Agent 144	As in production mode.

TABLE VI

Recovery Functionality after Completion of Rollback	
System Component	Behavior
Target Side Agent 164	Intercept SCSI commands issued to LU B (step 664). Redirect write transactions to DPA (step 672), and route read commands directly to LU B (step 680).
Target Side DPA 124	Apply TSP write transactions to LU B, in the same manner that write transactions received from DPA 112 are applied in production mode; i.e., by entering data into TSP UNDO and TSP UNDO METADATA streams (step 640). Enter DO information and write transactions received from DPA 112 into DO and DO METADATA streams, without applying them to LU B (step 644). Apply TSP write transactions to LU B as they are received (step 656).
Source Side DPA 112	As in production mode.
Source Side Agent 144	As in production mode.

It is also noted in FIG. 5 that the steps performed by target side DPA 124 include three non-sequential groups; namely, (i) step 540, (i) steps 548 and 552, and (iii) steps 556, 560, 564, 568 and 572. Similarly in FIG. 6 target side DPA performs three non-sequential groups of steps; namely, (i) step 640, (ii) steps 644 and 648, and (iii) steps 652, 656 and 660.

Reference is now made to FIG. 7, which is a simplified illustration of a time-line for tracking new processing of old data, in accordance with an embodiment of the present invention. FIG. 7 illustrates journal processor 180 bringing the timeline back to a previous time, TOLD, and journal processor 180 applying TSP writes to bring the timeline forward from time TCURRENT to time TNEW. As shown in FIG. 7, current data at time (1) is rolled back to old data at time (2). After rolling back the data to time (2), the rolled back data becomes the image upon which target side processing advances to new data at time (3); i.e., the target side processing is applied to data (2) and not to data (1).

The data at time (1) is a common image for LU A and LU B at the same point in time, TCURRENT. Similarly, the data at time (2) is a common image for LU A and LU B at time TOLD. Rolled back data at time (2) may be processed by TSP writes, while at the same time current data at time (1) is being processed by source side writes. As such, the data evolves

along the path from time (2) to time (3) as it is processed by the target side, and along the path from time (2) to time (4) as it is processed by the source side. The data images at the source and target sides at time TNEW are thus different.

When the recovery process is completed, the user may (i) return to a normal production mode, or (ii) perform a failover by switching the replication direction. In case (i), LU B is rolled back to its state at time (2), and the write transactions along the path from (2) to (4) are applied to LU B, so as to bring LU B to the same image as LU A. Conversely, in case (ii), LU B is maintained at its state at time (3), and its data is copied from the target side to the source side so as to bring LU A to the same image as LU B.

It may be appreciated that after rolling back the UNDO data stream to LU B, the state of the target side storage is substantially identical to the state that LU A was in at an earlier point in time. However, after applying TSP writes, the state of LU B is then in a new state that is different from the earlier state of LU A. As such, in order to return to a normal production mode, and ensure that LU B is a copy of LU A, DPA 124 undoes the TSP writes that were written to LU B using the TSP undo stream, and then returns to its normal production mode and begins applying the data that was written into the DO stream. The DO stream includes all write transactions that were undone while LU B was rolled back. Additionally, the DO stream includes new journal entries that were received from DPA 112 while DPA was in recovery mode. Similarly, protection agent 164 returns to its production mode by beginning to fail I/O requests issued by host 116.

Alternatively, the user want to perform a failover; i.e., to make LU B in its current state a production LU and ensure that LUA is a copy of LUB. In this case the write transactions in the DO stream that correspond to a point in time subsequent to the recovered point in time are ignored. Additionally, the TSP writes that were applied to LU B during the recovery process are applied to LU A. Thereafter, the replication direction changes. Specifically, DPA 124 and protection agent 164 begin behaving in accordance with source site behavior, and DPA 112 and protection agent 144 begin behaving in accordance with target site behavior.

It may be appreciated that in order to provide failover capability, in which the roles of the production site and the backup site are switched, it is desirable that the source side has the necessary system components to function as a target side, and vice versa. Thus, in an embodiment of the present invention, the source side includes its own journal LU 184 and journal processor 188, as indicated with dotted lines in FIG. 1.

Referring back to TABLE I, it may be appreciated that during normal data replication, for each write transaction received from a production site, there are five I/O operations performed at a backup site. Reference is now made to FIG. 8, which is a simplified illustration of a 5-stage journaling process for continuous data replication, in accordance with an embodiment of the present invention. The five steps shown in FIG. 8 correspond respectively to the five steps listed in TABLE I. For the sake of clarity, FIG. 8 only shows three meta-data elements; namely, a size, a journal address and a storage address. It may be appreciated that the meta-data in the DO METADATA and UNDO METADATA streams includes an ID, a time, and other attributes.

In accordance with an embodiment of the present invention, the meta-data for each transaction is of a fixed size, typically 30 bytes. The raw data varies in size, typically averaging around 10 KB per transaction.

As write transactions performed at a production site vary in frequency, and as each write transaction at the production site

normally requires five I/O transactions at the backup site, it may be appreciated that the size of the DO stream grows and shrinks accordingly. When the I/O rate is low, the beginning of the DO stream is close to the end of the DO stream. In such case, it is possible to keep all write transactions between the beginning and the end of the DO stream in memory, and there is no need to read the beginning of the DO stream for every new transaction received in the backup site. As such, step 2 may be skipped.

Reference is now made to FIG. 9, which is a simplified illustration of a 4-stage journaling process for continuous data replication, for use when an I/O data rate is low, in accordance with an embodiment of the present invention. The first step in FIG. 9 copies the write transaction to the end of the DO stream and the end of the DO METADATA stream, as in the 5-stage journaling process. Unlike, the 5-stage journaling process, though, instead of reading write transaction data from the beginning of the DO and DO METADATA streams, the 4-stage journaling process takes advantage of the fact that the write transaction that was just received at the backup site is still resident in memory. For this write transaction, steps 3-5 are performed, as indicated in FIG. 9.

However, during the steps 3-5 distribution of the write transaction that was just received, it is possible that a new transaction arrives at the backup site. In order to keep pace with the arriving transaction, as each write transaction is entered into the ends of the DO and DO METADATA streams, the write transaction is written into the end of a queue in memory. In accordance with an embodiment of the present invention, the queue in memory is handled similar to the way the DO stream is handled; namely, each received write is appended to the end of the queue, and when a write transaction is distributed according to steps 3-5, a subsequent write transaction is taken from the beginning of the queue. Effectively, the queue corresponds to a cached DO stream.

The 4-stage journaling process is used until the queue in memory is full, at which point the normal 5-stage journal processing is resumed. Also in the event of a disaster, the normal 5-stage journal processing is resumed. In order to resume the 5-stage journal processing, it is important to identify the last write in the DO stream that was written. As such, even during the 4-stage journal processing, the pointers to the first and last write transactions in the DO stream are updated.

Conversely, when the I/O rate is high, in order to control the size of the DO stream and ensure that it does not overflow its disk allotment, the present invention switches from the normal 5-stage mode to a faster 3-stage mode whenever the DO stream reaches a large percentage of its maximum capacity, typically 80%. The present invention afterwards switches back from the faster 3-stage mode to the normal 5-stage mode whenever the DO stream is reduced to a smaller percentage of its maximum capacity, typically 75%.

The 3-stage mode eliminates steps 3 and 4 from the normal mode; namely, the steps that record the UNDO information. As such, rollback of the backup storage unit to its state at the times of those transactions processed with the 3-stage mode is not possible.

Reference is now made to FIG. 10, which is a simplified illustration of a 3-stage journaling process for continuous data replication, for use when the DO stream is near its maximum capacity, in accordance with an embodiment of the present invention.

TABLE VII summarizes the relative pros and cons of each of the journaling processes described hereinabove.

TABLE VII

<u>Pros and Cons of Journaling Processes</u>		
Journaling Process	Pros	Cons
3-Stage Journaling	Fastest replication time	Long time to recover to current time
4-Stage Journaling	Moderate replication time; Full data recovery capability	Only able to be used as long as the beginning and the end of the DO stream are close
5-Stage Journaling	Full data recovery capability	Slowest replication time

One data replication strategy is the set of automated rules for controlling when a data replication system transitions between 5-stage, 4-stage and 3-stage journal processing. As mentioned hereinabove, transitions from 5-stage to 3-stage journaling, and from 3-stage back to 5-stage journaling, may be controlled based on the current size of the DO stream. Transitions from 5-stage to 4-stage journaling may be automated to occur when the beginning and end of the DO stream are close; and transitions from 4-stage back to 5-stage journaling may be automated to occur when the memory queue reaches its capacity.

Reference is now made to FIG. 11, which is a simplified state diagram of transitions between 5-stage, 4-stage and 3-stage journal processing, in accordance with an embodiment of the present invention. Shown in FIG. 11 are three nodes, representing each of the journaling processes, and directed edges between the nodes corresponding to rules that govern transitions therebetween. As shown in FIG. 11, a 5-stage to 3-stage transition occurs when the size of the DO stream exceeds 80% of its allotted capacity, and a 3-stage to 5-stage transition occurs when the size of the DO stream falls under 75% of its allotted capacity. Similarly, a 5-stage to 4-stage transition occurs when the beginning and end of the DO stream are close; and a 4-stage to 5-stage transition occurs when the memory queue reaches its capacity.

It will be appreciated by those skilled in the art that using 4-stage journaling enables a data replication system to keep pace with higher I/O rates than can be handled when using 5-stage journaling. If the system is currently using 5-stage journaling and the I/O rate is higher than can be handled, a lag increases until the system necessarily transitions to the 3-stage journaling process. However, if the system can catch up with the lag, empty the DO stream and transition to a 4-stage journaling process, then the system can accommodate higher I/O rates before transitioning back to the 5-stage journaling process.

In this regard, it is noted that in general, if the system cannot keep pace with I/O rates using a 4-stage journaling process, then it most probably cannot keep pace using a 5-stage journaling process, and in either case the system would have to transition to a 3-stage journaling process. However, since the I/O rate changes continuously, a transition from 4-stage journaling to 5-stage journaling does not necessarily push the system to 3-stage journaling.

Reference is now made to FIG. 12, which is a simplified illustration of a variant of the three-stage journaling process shown in FIG. 10, which may be used in an alternative embodiment of the present invention. The alternative 3-stage journaling proceeds according to the last three stages of the 4-stage journaling process. That is, the stage of writing to the DO stream is skipped within 4-stage journaling, for the alternative embodiment of 3-stage journaling. When performing 4-stage journaling, the backup site DPA (element 124 of FIG.

1) can return an acknowledgement to the production site DPA (element 112 of FIG. 1) immediately after the first stage, when the write transaction is written to the DO stream. However, when performing the alternative 3-stage journaling, the backup site DPA must wait until the write transaction is written to storage, before it can return an acknowledgement to the production site DPA. Since the last three stages of 4-stage journaling can be performed in a separate thread than the thread that performs the first stage, the alternative 3-stage journaling may result in a longer time lag between the source and target sites.

Each acknowledgement received by the production site DPA relates to a specific time, and thus the production site DPA can determine from the acknowledgement the amount of time lag between the backup site and the production site. A user may set a control parameter to configure the data replication system to constrain the time lag between the production and backup sites. When the time lag constraint is exceeded, the system regulates the lag by slowing down the production site application. As such, the alternative 3-stage journaling will generally hit the time lag constraint, and thereby cause a slow down in the production site application, more often than will the 4-stage journaling.

In reading the above description, persons skilled in the art will realize that there are many apparent variations that can be applied to the methods and systems described. Thus it may be appreciated that, in addition to data replication systems, the optimal journaling policy of the present invention has widespread application to journaling systems including database systems and version control systems.

In the foregoing specification, the invention has been described with reference to specific exemplary embodiments thereof. It will, however, be evident that various modifications and changes may be made to the specific exemplary embodiments without departing from the broader spirit and scope of the invention as set forth in the appended claims. Accordingly, the specification and drawings are to be regarded in an illustrative rather than a restrictive sense.

What is claimed is:

1. A method of replicating data, comprising:

- (a) receiving transactions comprising write data from a first data site to be backed up at a backup storage site;
- (b) writing the write data to a first position in a do data stream;
- (c) writing metadata for the write data to a first position in a do metadata stream, wherein the metadata for the write data in step (c) comprises a first field to store a size of the write data, a second field to store an address at which the write data is to be stored in the backup storage site and a third field to store a pointer to an offset in the do data stream where the write data is located;
- (d) reading data from a second position in the do data stream;
- (e) reading metadata from a second position in the do metadata stream;
- (f) reading data to be overwritten from a logical unit in the backup storage site, where location and size of the data to be overwritten is determined from the do metadata stream;
- (g) writing the data to be overwritten to a first position in an undo data stream;
- (h) writing metadata for the data to be overwritten in an undo metadata stream, the metadata for the data to be overwritten comprises a first field to store a size of the data to be overwritten, a second field to store an address at which the data is to be overwritten in the backup

storage site and a third field to store a pointer to an offset in the undo data stream where the data to be overwritten is located; and

(i) writing the write data to the logical unit in the backup storage site using the second field in the do metadata stream. 5

2. The method according to claim 1, further including undoing a write transaction by:

(j) reading data from the first position in the undo data stream and metadata from the first position in the undo metadata stream; 10

(k) reading data from the logical unit in the backup storage site that is to be overwritten, wherein location and size of the data is determined from the undo metadata stream;

(l) writing the data read from the logical unit in the backup storage site in step (k) to the second position of the do data stream; 15

(m) updating the do metadata stream;

(n) writing the data from the first position of the undo data stream to the logical unit in the backup storage site; and 20

(o) writing the metadata from the first position of the undo metadata stream to the logical unit in the backup storage site.

3. The method according to claim 1, further including omitting steps (d) and (e) where a number of the write data transactions from the first data site to be backed up per unit time is less than a predetermined amount. 25

4. The method according to claim 3, further including performing steps (d) and (e) again when a queue memory is more than a given percent full. 30

5. The method according to claim 1, further including omitting steps (f), (g), and (h) when a size of the do data stream is greater than a given value.

6. The method according to claim 1, further including omitting steps associated with the undo data stream and undo metadata stream when the do data stream becomes larger than a given value. 35

7. The method according to claim 1, further including providing a state machine to transition between a number of states having a given number of processing stages, wherein 40

a first state includes steps (a)-(i);

a second state includes omitting steps (d) and (e) where a number of the write data transactions from the first data site to be backed up per unit time is less than a predetermined amount; and 45

a third state includes omitting steps (f), (g), and (h) when a size of the do data stream is greater than a given value.

8. The method according to claim 7, wherein the state machine has three nodes.

9. The method according to claim 1, further including omitting steps (b)-(e) to provide a state in a state machine for transitioning between a number of states having a given number of processing stages. 50

10. An article, comprising:

a storage medium having stored thereon instructions that when executed by a machine result in the following: 55

(a) receiving write data transactions from a first data site to be backed up at a backup storage site;

(b) writing the write data to a first position in a do data stream; 60

(c) writing metadata for the write data to a first position in a do metadata stream, wherein the metadata for the write data in step (c) comprises a first field to store a size of the write data, a second field to store an address at which the write data is to be stored in the backup storage site and a third field to store a pointer to an offset in the do data stream where the write data is located; 65

(d) reading data from a second position in the do data stream;

(e) reading metadata from a second position in the do metadata stream;

(f) reading data to be overwritten from a logical unit in the backup storage site, where location and size of the data to be overwritten is determined from the do metadata stream;

(g) writing the data to be overwritten to a first position in an undo data stream;

(h) writing metadata for the data to be overwritten to an undo metadata stream, the undo metadata comprises a first field to store a size of the data to be overwritten, a second field to store an address at which the data is to be overwritten in the backup storage site and a third field to store a pointer to an offset in the undo data stream where the data to be overwritten is located; and

(i) writing the write data to the logical unit in the backup storage site using the second field in the do metadata stream.

11. The article according to claim 10, further including instructions for undoing a write transaction by:

(j) reading data from the first position in the undo data stream and metadata from the first position in the undo metadata stream;

(k) reading data from logical unit in the backup storage site that is to be overwritten, wherein location and size of the data is determined from the undo metadata stream;

(l) writing the data read from the logical unit in the backup storage site in step (k) to the second position of the do data stream;

(m) updating the do metadata stream;

(n) writing the data from the first position of the undo data stream to the logical unit in the backup storage site; and

(o) writing the metadata from the first position of the undo metadata stream to the logical unit in the backup storage site.

12. The article according to claim 10, further including instructions for 60

omitting steps (d) and (e) where a number of the write data transactions from the first data site to be backed up per unit time is less than a predetermined amount.

13. The article according to claim 12, further including instructions for performing steps (d) and (e) again when a queue memory is more than a given percent full.

14. The article according to claim 10, further including instructions for omitting steps (f), (g), and (h) when a size of the do data stream is greater than a given value.

15. The article according to claim 10, further including instructions for omitting steps associated with the undo data stream and undo metadata stream when the do data stream becomes larger than a given value.

16. The article according to claim 10, further including instructions providing a state machine to transition between a number of states having a given number of processing stages, wherein 65

a first state includes steps (a)-(i);

a second state includes omitting steps (d) and (e) where a number of the write data transactions from the first data site to be backed up per unit time is less than a predetermined amount; and

a third state includes omitting steps (f), (g), and (h) when a size of the do data stream is greater than a given value.